

---

# CAME

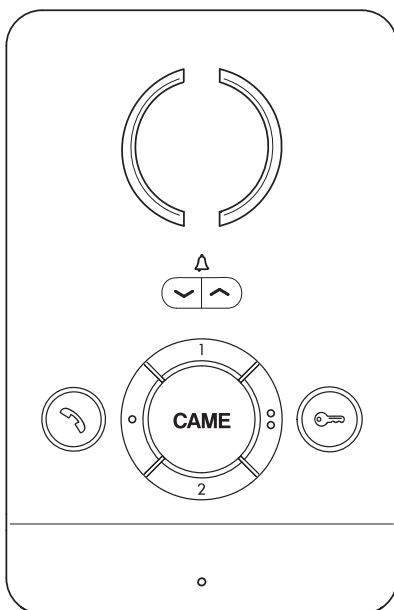

**001CS1BNC0**

**Manuale Utente**

IT

**User's manual**

EN

**Benutzerhandbuch**

DE

**Manuel Utilisateur**

FR

**Manual del usuario**

ES

**Manual do Utilizador**

PT

**Gebruikersaanwijzingen**

NL

**QUESTE ISTRUZIONI DEVONO ESSERE ALLEGATE ALL'APPARECCHIO**

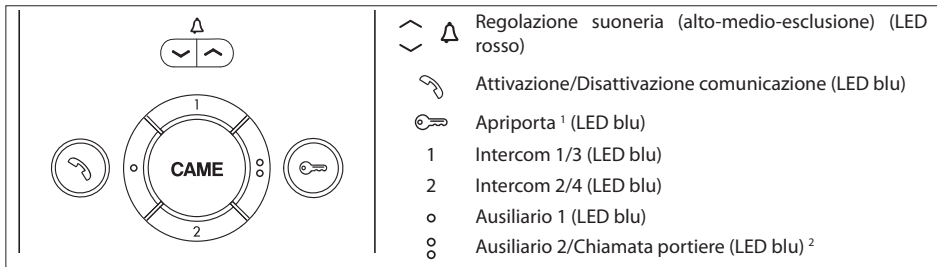

1 In impianti predisposti per questa segnalazione, durante una chiamata da posto esterno, il LED accesso fisso indica che la porta è aperta.

2 La funzione può essere disponibile anche quando la comunicazione non è attiva se il sistema lo permette.

**Funzioni base**

**Rispondere a una chiamata**

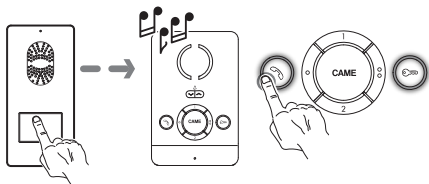

Rispondere a una chiamata

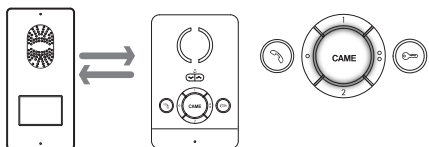

Comunicazione attiva

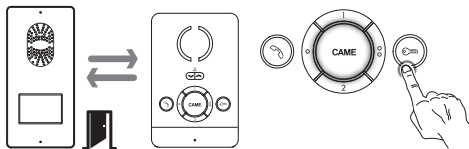

Apriporta del posto esterno

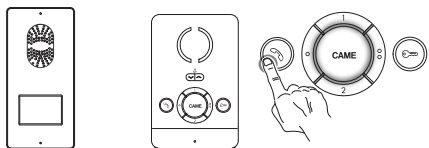

Chiudere la comunicazione

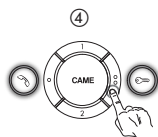
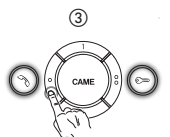
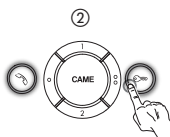
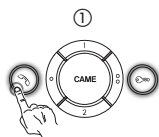

**Funzioni disponibili durante una chiamata**



Attivazione comunicazione ①, apertura della porta del posto esterno selezionato ② e attivazione dei comandi ausiliari ③ ④.

## Esclusione della Suoneria



Per escludere la suoneria premere il pulsante  finchè il LED si accende. La suoneria sarà esclusa per qualsiasi tipo di chiamata. Premere il pulsante  per regolare nuovamente il volume della suoneria.

## Intercomunicazione

### Chiamata agli interni

#### INTERCOM 1/3

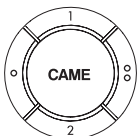

Per chiamare gli interni 1 e 2 (3 o 4) premere i pulsanti relativi.

#### INTERCOM 2/4

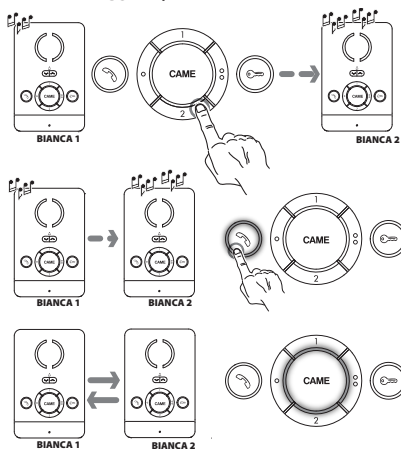

Dopo aver selezionato l'interno desiderato il derivato chiamante emetterà un tono di linea libera, mentre il derivato chiamato squillerà con il tono scelto.

Per attivare la comunicazione audio è necessario premere il tasto  del derivato chiamato.

Durante una conversazione fra interni una chiamata da posto esterno viene segnalata ai derivati da un beep ripetuto ogni 5".

3 beep successivi indicano che non è possibile effettuare chiamate perchè la linea è occupata.

### Trasferimento di chiamata

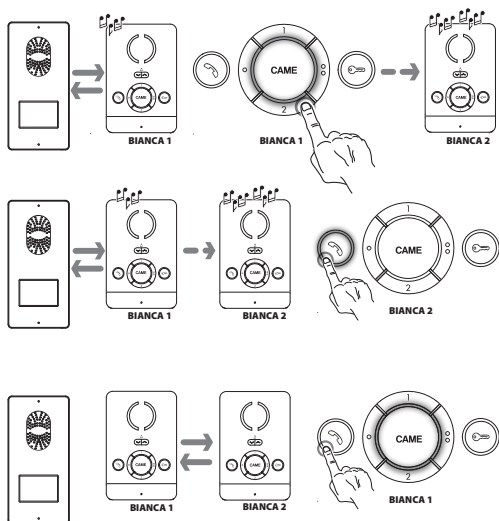

Con una comunicazione attiva, selezionare l'interno al quale si vuole trasferire la chiamata (il derivato chiamante emetterà un tono di linea libera, mentre il derivato chiamato squillerà con il tono scelto). Per attivare la comunicazione audio è necessario premere il tasto  del derivato chiamato.

Una volta stabilita la connessione audio con l'interno desiderato, premere  per trasferire la chiamata. L'interno che riceve la chiamata potrà ritrasferirla.

## Funzioni di Portineria



Le funzioni descritte nel presente paragrafo sono disponibili solo in impianti dotati di postazione di portineria.

### Chiamata dal portiere

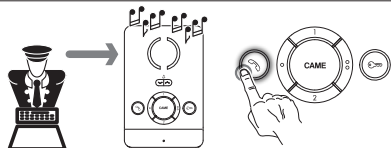

Premere il pulsante per rispondere.

### Notifica di chiamata da portiere

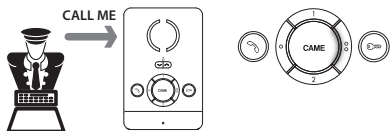

La notifica viene segnalata dall'accensione del LED Aux2 . Il LED si spegne quando si entra in comunicazione con il portiere.

### Richiesta di chiamata al portiere

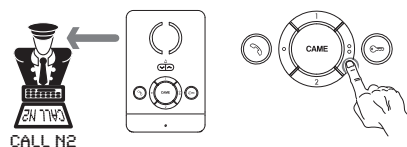

Richiesta di chiamata al portiere

## PROGRAMMAZIONE

Per la programmazione della chiamata, vedere la documentazione dei posti esterni.

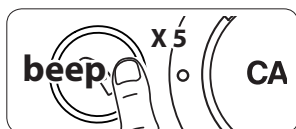

①

**Ingresso in Programmazione.** Premere 5 volte il pulsante entro 5 s. Un breve segnale acustico conferma l'ingresso in programmazione ①.



②

**Programmazione della melodia associata alla chiamata dal posto esterno (1 segnale acustico).** per ascoltare le melodie in sequenza, premere il pulsante ②. Per selezionare la melodia ed uscire dalla programmazione premere il tasto ③. Per selezionare la melodia e proseguire con la programmazione premere il tasto ④.

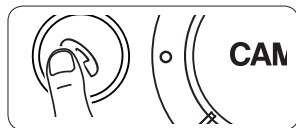

③

**Programmazione della melodia associata alla chiamata dal pianerottolo (2 segnali acustici).** Per questo tipo di programmazione ② ③ ④ procedere come la "Programmazione della melodia associata alla chiamata dal posto esterno" precedentemente descritta.

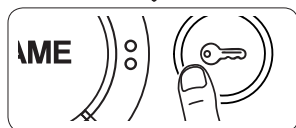

④

**Programmazione del numero di squilli di chiamata (3 segnali acustici).** Premere il tasto tante volte quanti sono gli squilli che si è scelto per la chiamata (da 1 a 6 squilli) ⑤. 3 s dall'ultima pressione del tasto verrà riprodotta la chiamata selezionata per il numero di squilli prescelto. Per selezionare la melodia ed uscire dalla programmazione premere il tasto ⑥.



⑤



⑥

**ⓘ Per la pulizia utilizzare solo panni morbidi ed asciutti oppure leggermente inumiditi con acqua; non utilizzare alcun tipo di prodotto chimico.**

IT

### **SMALTIMENTO**

Assicurarsi che il materiale d'imballaggio non venga disperso nell'ambiente, ma smaltito seguendo le norme vigenti nel paese di utilizzo del prodotto.

Alla fine del ciclo di vita dell'apparecchio evitare che lo stesso venga disperso nell'ambiente.

Lo smaltimento dell'apparecchiatura deve essere effettuato rispettando le norme vigenti e privilegiando il riciclaggio delle sue parti costituenti.

Sui componenti, per cui è previsto lo smaltimento con riciclaggio, sono riportati il simbolo e la sigla del materiale.



**THESE INSTRUCTIONS SHOULD BE ATTACHED TO THE UNIT**

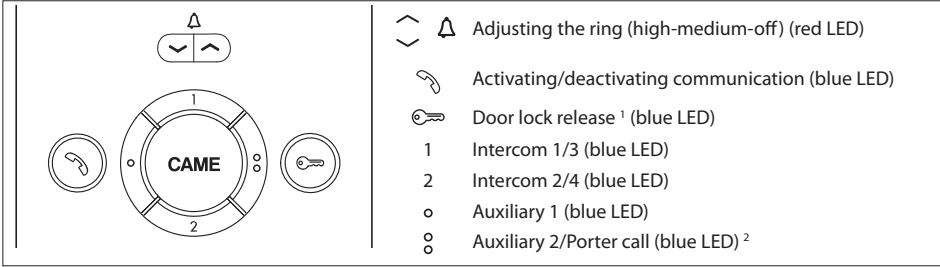

1 In systems designed to accommodate this signal, during a call from an entry panel, the LED lit permanently indicates that the door is open.

2 The function may also be available with communication is not activated, where the system permits it.

**Standard functions**

**Answering a call**

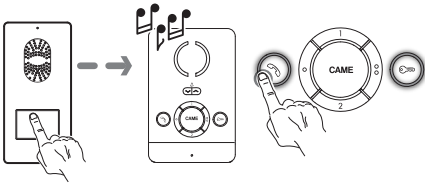

Answering a call

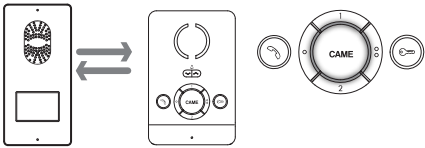

Communication active

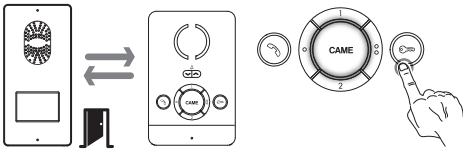

Entry panel door release displayed

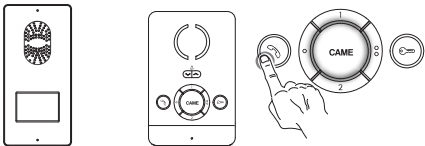

Ending communication

**Functions available during a call**

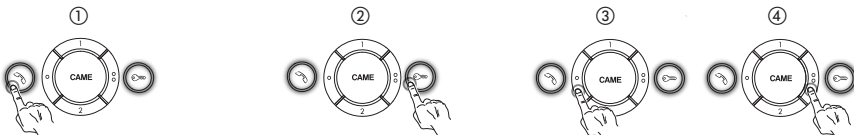



Activation of communication ①, opening of the door of the selected entry panel ② and activation of the auxiliary controls ③ ④.

EN

## Disabling the ring



To disable the ring, press the button  until the corresponding LED lights up. The ring will be disabled for all call types. Press the button  to adjust the volume of the ring again.

## Intercommunication

### Calling extensions

#### INTERCOM 1/3

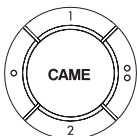

Press the relative buttons to call extensions 1 and 2 (3 or 4).

#### INTERCOM 2/4

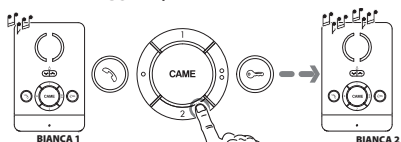

After selecting the desired extension, the caller will emit a line free tone, while the receiver called will ring with the chosen tone.

To activate audio communication, press the button  on the receiver.

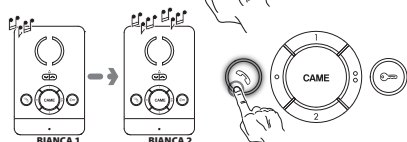

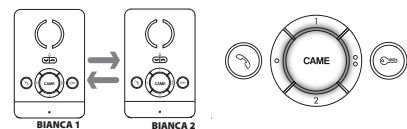

During a conversation between extensions, a call from an entry panel is signalled to the receivers by a beep, which is repeated every 5".

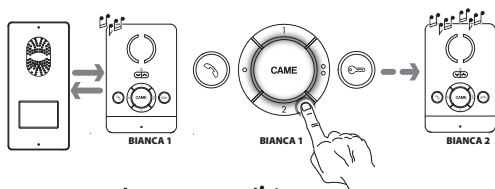

3 beeps in a row indicate that it is not possible to make calls because the line is busy.

### Call transfer



With an active communication, select the extension you wish to transfer the call to (the caller will emit a line free tone, while the receiver called will ring with the chosen tone). To activate audio communication, press the button  on the receiver.



Once the audio connection is established with the desired receiver, press  to transfer the call. The receiver of the call can transfer it back.

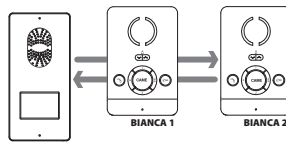
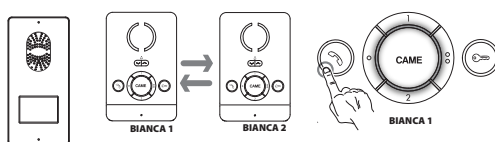

## Porter functions



The functions described in this paragraph are only available in systems featuring a porter station.

### Porter call

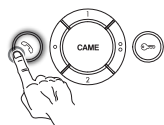
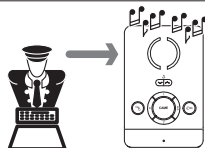

Press the button to answer.

### Porter call notification



The notification is signalled by the Aux2 LED lighting up . The LED is turned off when communication with the porter is established.

### Porter call request

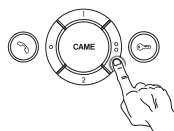
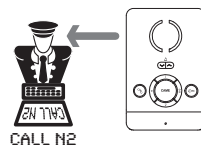

Porter call request

## PROGRAMMING

For call programming, see the entry panel documentation.

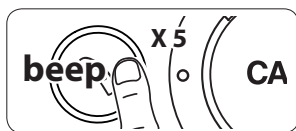

①



②

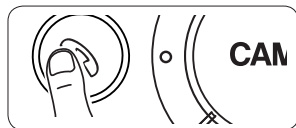

③

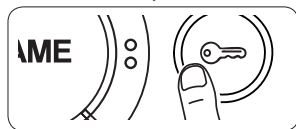

④



⑤



⑥

**Accessing programming** Press the button five times within 5 s. A brief acoustic signal will confirm that programming has been accessed ①.

**Programming the melody associated with the call from the entry panel (1 acoustic signal).** To listen to the melodies in sequence, press the button ②. To select the melody and exit programming, press the button ③. To select the melody and continue with programming, press the button ④.

**Programming the melody associated with the doorbell (2 acoustic signals).** For this type of programming ② ③ ④ proceed as previously described for "Programming the melody associated to the call from the entry panel".

**Programming the number of call rings (3 acoustic signals).** press the button the number of times equal to the number of rings selected for the call (from 1 to 6 rings) ⑤. 3 s after the button is pressed the last time, the call selected for the selected number of rings will be reproduced. To select the melody and exit programming, press the button ⑥.



** Only use soft, dry or slightly damp cloths to clean the terminal; do not use any chemical products.**

**EN**

### **DISPOSAL**

Do not litter the environment with packing material: make sure it is disposed of according to the regulations in force in the country where the product is used.

When the equipment reaches the end of its life cycle, take measures to ensure it is not discarded in the environment. The equipment must be disposed of in compliance with the regulations in force, recycling its component parts wherever possible.

Components that qualify as recyclable waste feature the relevant symbol and the material's abbreviation.



**DIESE ANLEITUNGEN MÜSSEN DEM GERÄT BEILIEGEN**

	<ul style="list-style-type: none"> <li> Läutwerkeinstellung (laut-mittel-ausgeschaltet) (rote LED)</li> <li> Freischaltung/Abschaltung der Sprechstelle (blaue LED)</li> <li> Türöffner <sup>1</sup> (Blaue LED)</li> <li>1 Intercom 1/3 (blaue LED)</li> <li>2 Intercom 2/4 (blaue LED)</li> <li>o Aux 1 (blaue LED)</li> <li>o Aux 2/Pförtnerruf (blaue LED) <sup>2</sup></li> </ul>
--	--

1 Wenn die LED-Anzeige bei Anlagen, die über diese Anzeige verfügen, während eines Anrufs von der Außenstation aufleuchtet, ist die Tür offen.

2 Die Funktion steht auch dann zur Verfügung, wenn die Sprechverbindung nicht freigeschaltet wurde und das System dies ermöglicht.

**Grundfunktionen**

**Auf einen Anruf antworten**

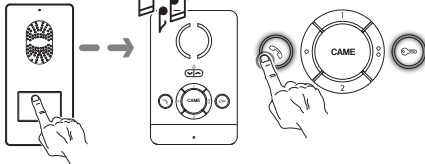

Auf einen Anruf antworten

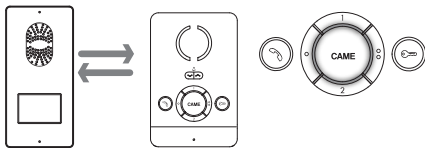

Active Sprechverbindung

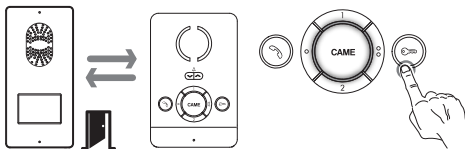

Türöffner der Außenstation

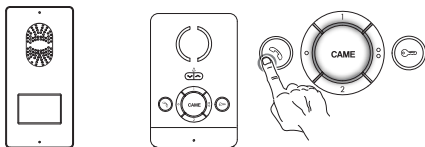

Ausschalten der Sprechverbindung

**Während eines Anrufs verfügbare Funktionen**

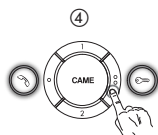
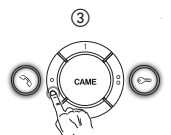
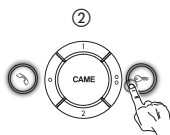
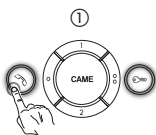

Freischaltung der Kommunikation ①, Öffnen der Tür der ausgewählten Außenstation ② und Freischaltung der Zusatzsteuerungen ③ ④.

## Lautwerkabschaltung



Um das Lautwerk abzuschalten, die Taste  drücken, bis die LED aufleuchtet. Das Lautwerk ist für jeden Anruf ausgeschaltet. Die Taste  drücken, um das Lautwerk wieder einzuschalten.

## Intercom-Funktion

### Innensprechstellen

#### INTERCOM 1/3

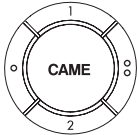

Um die Innensprechstellen 1 und 2 anzurufen (3 oder 4) auf die entsprechenden Tasten drücken.

#### INTERCOM 2/4

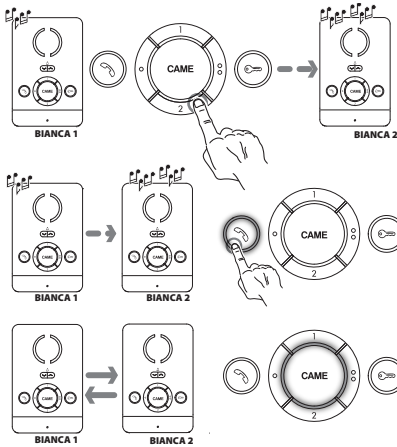

Nach Auswahl der gewünschten Innensprechstelle, ertönt an der anrufenden Sprechstelle ein Freiton, während an der angerufenen Sprechstelle der ausgewählte Klingelton ertönt.

Um die Audio-Verbindung freizuschalten muss die Taste  der angerufenen Sprechstelle gedrückt werden.

Ein während eines Gesprächs zwischen Innensprechstellen eingehender Anruf von einer Außenstation wird an den Innensprechstellen mit einem alle 5" wiederholten Piepton angezeigt.

3 aufeinanderfolgende Pieptöne zeigen an, dass keine Anrufe getätigt werden können, weil die Leitung besetzt ist.

### Anrufweiterleitung

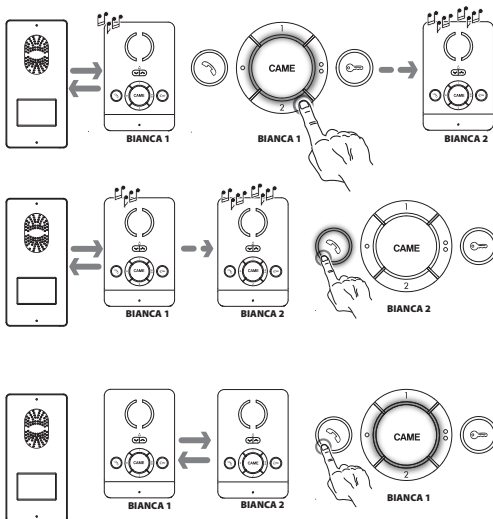

Während eines Gesprächs, die Innensprechstelle auswählen, an die der Anruf weitergeleitet werden soll (an der anrufenden Sprechstelle ertönt ein Freiton, während an der angerufenen Sprechstelle der ausgewählte Klingelton ertönt). Um die Audio-Kommunikation einzuschalten, muss die Taste  der angerufenen Innensprechstelle gedrückt werden.

Nach Herstellung der Audio-Verbindung mit der gewünschten Innensprechstelle, die Taste  drücken, um das Gespräch weiterzuleiten. Das Gespräch kann von der angewählten Innensprechstelle weitergeleitet werden.

DE

## Funktionen des Pförtnerpostens



Die in diesem Abschnitt beschriebenen Funktionen stehen nur bei Anlagen mit Pförtnerposten zur Verfügung.

### Pförtnerurf

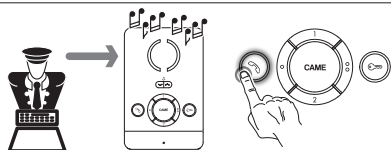

Zum Antworten die Taste drücken.

### Rufmitteilung vom Pförtnerposten

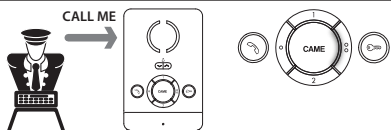

Die Mitteilung wird durch das Aufleuchten der LED Aux2 angezeigt. Die LED geht aus, sobald eine Verbindung zum Pförtner hergestellt ist.

### Pförtnerurf

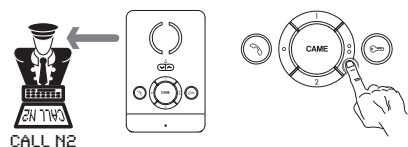

Pförtnerurf

## PROGRAMMIERUNG

Für die Rufprogrammierung, siehe die Unterlagen der Außenstationen.

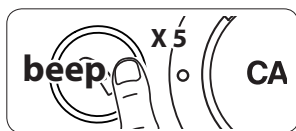

①

**Zugang zur Programmierung.** Innerhalb von 5 Sek. 5 Mal den Taster drücken. Ein kurzer Signalton bestätigt den Einstieg in die Programmierung ①.



②

**Programmierung der dem Anruf durch die Außenstation zugeordneten Melodie (1 Signalton).** Um die Melodien nacheinander anzuhören, die Taste ② drücken. Um die Melodie auszuwählen und aus der Programmierung auszusteigen die Taste ③ drücken. Um die Melodie auszuwählen und die Programmierung fortzuführen, die Taste ④ drücken.

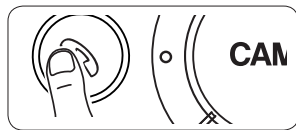

③

**Programmierung der einem Anruf vom Treppenhaus zugeordneten Melodie (2 Signaltöne).** Für diese Programmierungsweise ② ③ ④ wie in der zuvor beschriebenen "Programmierung der dem Anruf durch die Außenstation zugeordneten Melodie" vorgehen.

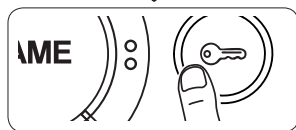

④

**Programmierung der Anzahl der Ruftöne (3 Signaltöne).** Die Taste so oft drücken, wie die für den Anruf gewünschten Ruftöne (1 bis 6 Ruftöne) ⑤. 3 Sek. nach dem letzten Tastendruck wird der gewählte Anruf mit der Anzahl der festgelegten Ruftöne wiederholt. Um die Melodie auszuwählen und aus der Programmierung auszusteigen die Taste ⑥ drücken.



⑤



⑥

**F** Nur mit weichen und trockenen bzw. leicht mit Wasser angefeuchteten Tüchern reinigen; keine chemischen Reinigungsmittel verwenden.

DE

### ENTSORGUNG

Vergewissern Sie sich, dass das Verpackungsmaterial gemäß den Vorschriften des Bestimmungslandes ordnungsgemäß und umweltgerecht entsorgt wird.

Das nicht mehr benutzbare Gerät muss umweltgerecht entsorgt werden und darf nicht in die Umwelt gelangen.

Das Gerät muss gemäß den geltenden Vorschriften entsorgt werden, dabei muss das Recycling der Bestandteile des Geräts bevorzugt werden.

Die wiederverwertbaren Bestandteile des Geräts, sind mit einem Symbol und dem Material-Kürzel gekennzeichnet.



**CES INSTRUCTIONS DOIVENT ACCOMPAGNER L'APPAREIL**

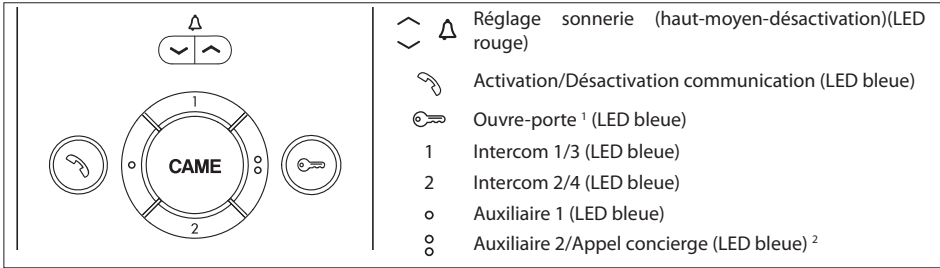

1 Sur les installations prévues pour cette signalisation, durant un appel depuis le poste extérieur, la LED allumée en permanence indique que la porte est ouverte.

2 Si le système le permet, la fonction peut également être disponible lorsque la communication n'est pas activée.

**Fonctions de base**

**Répondre à un appel**

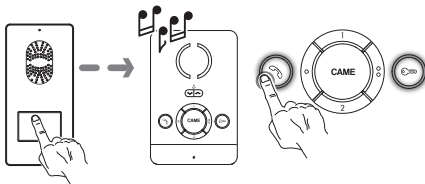

Répondre à un appel

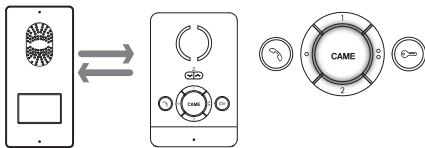

Communication activée

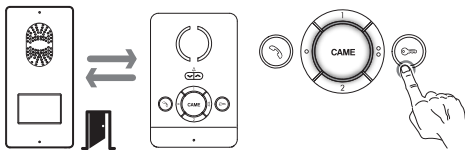

Ouvre-porte du poste extérieur

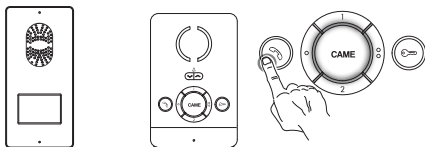

Couper la communication

FR

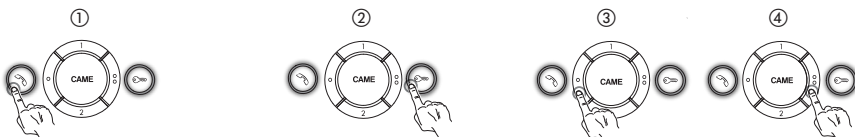

**Fonctions disponibles durant un appel**



Activation de la communication ①, ouverture de la porte du poste extérieur sélectionné ② et activation des commandes auxiliaires ③ ④.

## Désactivation de la sonnerie



Pour désactiver la sonnerie, appuyer sur le bouton  jusqu'à ce que la LED s'allume. La sonnerie sera désactivée pour tout type d'appel. Appuyer de nouveau sur le bouton  pour réactiver la sonnerie.

## Intercommunication

### Appeler les postes intérieurs

#### INTERCOM 1/3

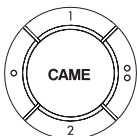

Pour appeler les postes intérieurs de 1 à 2 (3 ou 4), appuyer sur les boutons correspondants.

#### INTERCOM 2/4

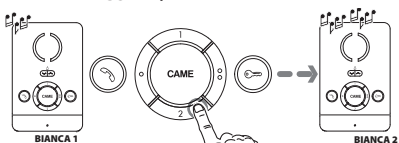

Après avoir sélectionné le poste intérieur souhaité, le poste appelant émettra une tonalité de ligne libre, tandis que le poste appelé sonnera avec la tonalité choisie. Pour activer la communication audio, il est nécessaire d'appuyer sur la touche  du poste appelé.

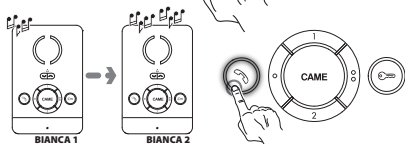

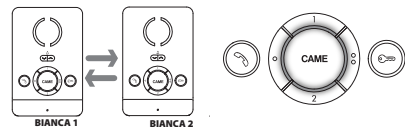

Durant une conversation entre postes intérieurs, un appel depuis le poste extérieur est signalé aux postes intérieurs par un bip répété toutes les 5".



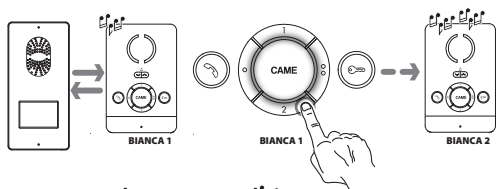

3 bips successifs indiquent qu'il est impossible d'effectuer des appels car la ligne est occupée.

### Transfert d'appel

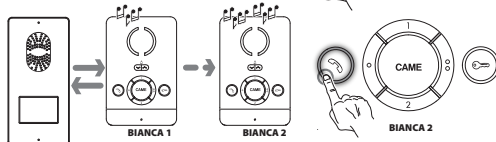

Avec une communication activée, sélectionner le poste intérieur vers lequel transférer l'appel (le poste appelant émettra une tonalité de ligne libre, tandis que le poste appelé sonnera avec la tonalité choisie). Pour activer la communication audio, il est nécessaire d'appuyer sur la touche  du poste appelé.



Une fois la connexion audio établie avec le poste souhaité, appuyer sur  pour transférer l'appel. Le poste qui reçoit l'appel pourra le retransférer.

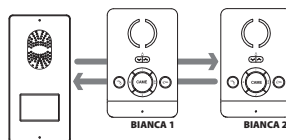
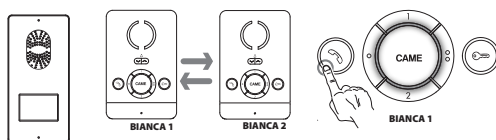

## Fonctions de Conciergerie



Les fonctions décrites dans le présent paragraphe ne sont disponibles que sur les installations équipées de poste de conciergerie.

### Appel du concierge

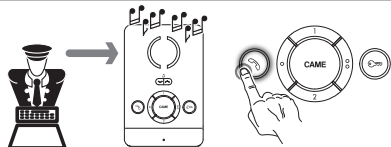

Appuyer sur le bouton pour répondre.

### Avis d'appel du concierge

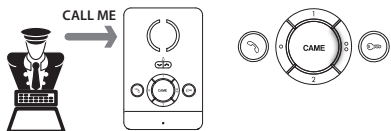

L'avis est signalé par l'allumage de la LED Aux2 . La led s'éteint lorsque l'on entre en communication avec le concierge.

### Demande d'appel au concierge

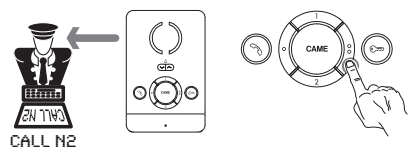

Demande d'appel au concierge.

## Programmation

Pour la programmation de l'appel, voir la documentation des postes extérieurs.

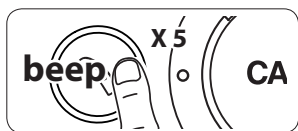

①

**Entrée en Programmation.** Appuyer 5 fois sur la touche dans les 5 s. Un bref signal sonore confirme l'entrée dans la programmation ①.



②

**Programmation de la mélodie associée à l'appel provenant du poste extérieur (1 signal sonore).** Pour écouter les mélodies en séquence, appuyer sur la touche ②. Pour sélectionner la mélodie et quitter la programmation, appuyer sur la touche ③. Pour sélectionner la mélodie et continuer la programmation, appuyer sur la touche ④.

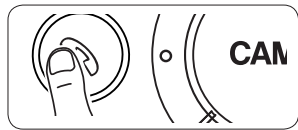

③

**Programmation de la mélodie associée à l'appel provenant du palier (2 signaux sonores).** Pour ce type de programmation ② ③ ④ procéder comme pour la "Programmation de la mélodie associée à l'appel provenant du poste extérieur" décrite précédemment.

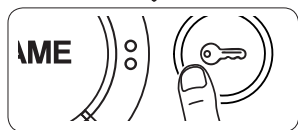

④

**Programmation du nombre de sonneries d'appel (3 signaux sonores).** Appuyer sur la touche autant de fois que le nombre de sonneries que l'on a choisi pour l'appel (de 1 à 6 sonneries) ⑤. 3 s après le dernier enfoncement de la touche, l'appel sélectionné pour le nombre de sonneries choisi sera effectué. Pour sauvegarder la mélodie et quitter complètement la programmation, appuyer sur la touche ⑥.



⑤



⑥



**ⓘ Pour le nettoyage, n'utiliser que des chiffons doux et secs ou légèrement imbibés d'eau ; n'utiliser aucun type de produit chimique.**

FR

### Élimination

S'assurer que le matériel d'emballage n'est pas abandonné dans la nature et qu'il est éliminé conformément aux normes en vigueur dans le pays d'utilisation du produit.

À la fin du cycle de vie de l'appareil, faire en sorte qu'il ne soit pas abandonné dans la nature.

L'appareil doit être éliminé conformément aux normes en vigueur et en privilégiant le recyclage de ses pièces.

Le symbole et le sigle du matériau sont indiqués sur les pièces pour lesquelles le recyclage est prévu.



**ESTAS INSTRUCCIONES SE DEBEN ANEXAR AL APARATO**

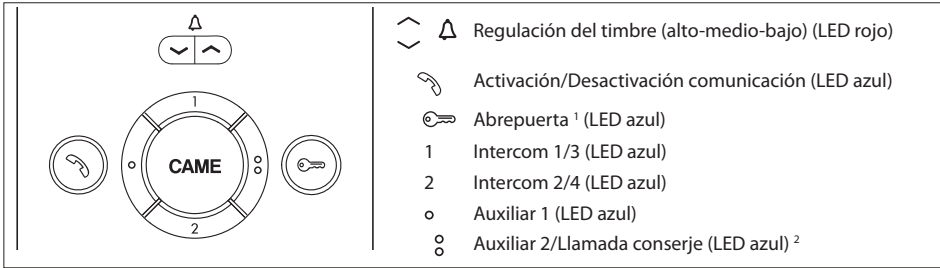

1 En instalaciones preparadas para esta indicación, durante una llamada desde placa exterior, el LED encendido fijo indica que la puerta está abierta.

La función también puede estar disponible cuando la comunicación no está activada si el sistema lo permite.

**Funciones básicas**

**Responder a una llamada**

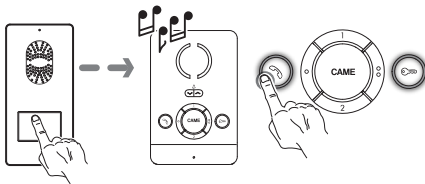

Responder a una llamada

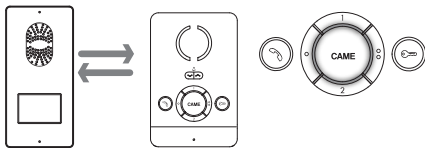

Comunicación activada

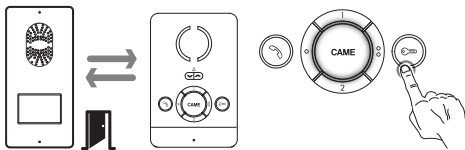

Abrepuerta de la placa exterior

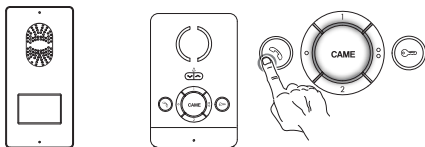

Cortar la comunicación

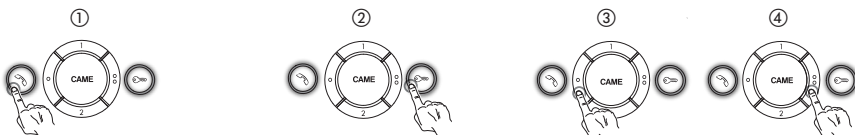

**Funciones disponibles durante una llamada**



Activación de la comunicación ①, abertura de la puerta de la placa exterior seleccionada ② y activación de los mandos auxiliares ③ ④.

## Inhabilitación del timbre



Para deshabilitar el timbre pulse el botón  hasta que el LED correspondiente se encienda. El timbre quedará deshabilitado para todo tipo de llamada. Pulse el botón  para regular nuevamente el volumen del timbre.

## Intercomunicación

### Llamada a los internos

#### INTERCOM 1/3

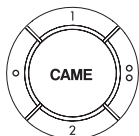

Para llamar a los internos del 1 y 2 (3 o 4) pulse los botones correspondientes.

#### INTERCOM 2/4

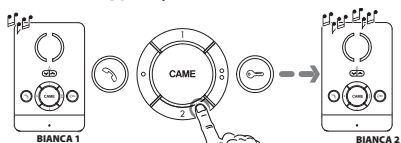

Tras seleccionar el interno deseado, el derivado llamante emitirá un tono de línea libre, mientras que el derivado llamado sonará con el tono elegido.

Para activar la comunicación audio se debe pulsar el botón  del derivado llamado.

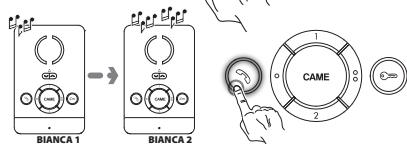

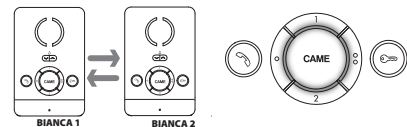

Durante una conversación entre internos, si se produce una llamada desde placa exterior, se indica a los derivados mediante un pitido repetido cada 5 segundos.

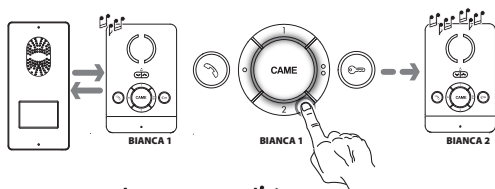

3 pitidos consecutivos indican que no se pueden realizar llamadas porque la línea está ocupada.

### Transferencia de llamada



Con una comunicación activada, seleccione el interno al que desea transferir la llamada (el derivado llamante emitirá un tono de línea libre, mientras que el derivado llamado sonará con el tono elegido). Para activar la comunicación audio se debe pulsar el botón  del derivado llamado.



Una vez establecida la conexión audio con el interno deseado, pulse  para transferir la llamada. El interno que recibe la llamada podrá volver a transferirla.

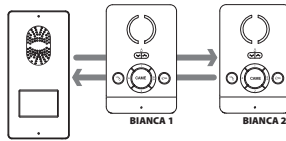
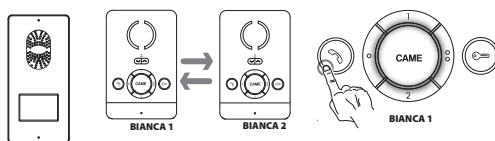

## Funciones de Conserjería



Las funciones descritas en este apartado sólo están disponibles en instalaciones que incluyan puesto de conserjería.

### Llamada del conserje

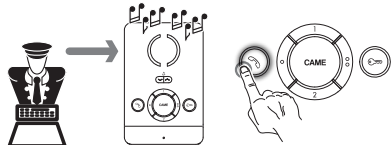

Pulse el botón para responder

### Aviso de llamada del conserje

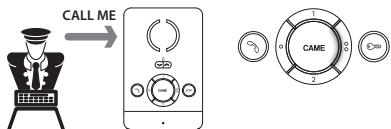

El aviso se indica con el encendido del LED Aux2 . El led se apaga cuando se establece la comunicación con el conserje.

### Solicitud de llamada al conserje

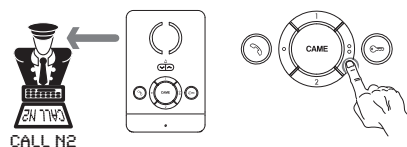

Solicitud de llamada al conserje

## PROGRAMACIÓN

Para programación de la llamada, véase documentación de las placas externas.

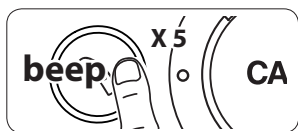

①

**Entrada en Programación.** Pulse 5 veces el botón e 5 s. Una señal acústica breve confirma la entrada en programación ①.



②

**Programación de la melodía asociada a la llamada desde placa exterior (1 señal acústica).** Para escuchar las melodías una después de otra, pulsar el botón ②. Para seleccionar la melodía y salir de la programación, pulsar el botón ③. Para seleccionar la melodía y proseguir con la programación, pulsar el botón ④.

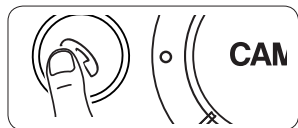

③

**Programación de la melodía asociada a la llamada desde el rellano (2 señales acústicas).** Para este tipo de programación ② ③ ④ siga los mismos pasos que para la "Programación de la melodía asociada a la llamada desde la placa exterior" descrita previamente.

**Programación del número de tonos de llamada (3 señales acústicas).** Pulse el botón un número de veces igual a los tonos que se desean para la llamada (de 1 a 6 tonos) ⑤. Pasados 3 s desde la última vez que se pulse el botón, se reproducirá la llamada seleccionada con el número de tonos elegido. Para guardar la melodía seleccionada y salir completamente de la modalidad de programación, pulse el botón ⑥.

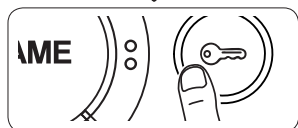

④



⑤



⑥

**Para la limpieza utilice solo paños suaves y secos o ligeramente humedecidos en agua; no utilice ningún tipo de producto químico.**

## **ELIMINACION**

Comprobar que no se tire al medioambiente el material de embalaje, sino que sea eliminado conforme a las normas vigentes en el país donde se utilice el producto.

Al final del ciclo de vida del aparato evítase que éste sea tirado al medioambiente.

La eliminación del aparato debe efectuarse conforme a las normas vigentes y privilegiando el reciclaje de sus partes componentes.

En los componentes, para los cuales está prevista la eliminación con reciclaje, se indican el símbolo y la sigla del material.

**ES**



**ESTAS INSTRUÇÕES DEVEM ACOMPANHAR O APARELHO**

		Ajuste de aviso sonoro (alto-médio-exclusão) (LED vermelho)
		Activação /Desactivação de comunicação (LED azul)
		Abrir porta <sup>1</sup> (LED azul)
		Intercom 1/3 (LED azul)
		Intercom 2/4 (LED azul)
		Auxiliar 1 (LED azul)
	Auxiliar 2/Chamada porteiro (LED azul) <sup>2</sup>	

1 Em instalações preparadas para esta assinalação, durante uma chamada do posto externo, o LED acesso fixo indica que a porta está aberta.

2 A função pode ser disponível mesmo quando a comunicação não estiver activa se o sistema o permitir.

**Funções de base**

**Responder uma chamada**

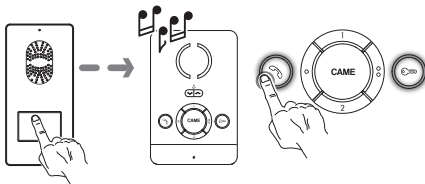

Responder uma chamada

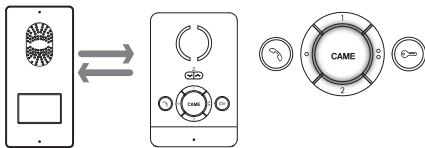

Comunicação activa

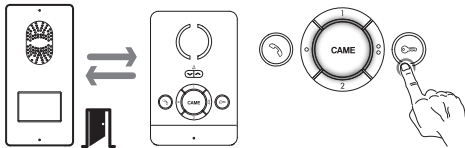

Abrir porta do posto externo

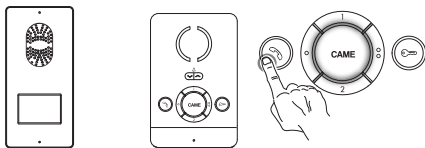

Interromper a comunicação

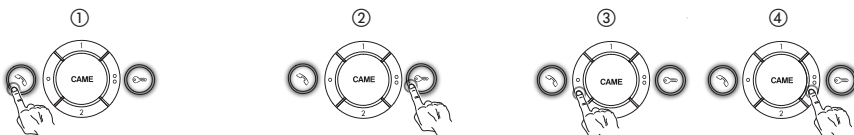

**Funções disponíveis durante uma chamada**



Activação de comunicação ①, abertura da porta do posto externo seleccionada ② e activação dos comandos auxiliares ③ ④.

## Exclusão de avisos sonoros



Para excluir os avisos sonoros, prema o botão  até que o LED se acenda. O aviso sonoro será excluído para todo tipo de chamada. Prema o botão  para ajustar novamente o volume do aviso sonoro.

## Intercomunicação

### Chamada a números internos

#### INTERCOM 1/3

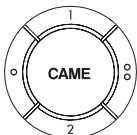

Para chamar os internos 1 e 2 (3 ou 4) prema os botões relativos.

#### INTERCOM 2/4

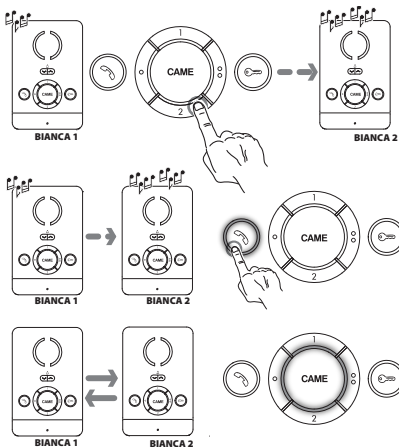

Depois de ter seleccionado o número interno desejado, o derivado chamante soará um toque de linha livre, enquanto que o derivado chamado soará um toque escolhido.

Para activar a comunicação audio é necessário premer a tecla  do derivado chamado.

Durante uma conversação entre internos, uma chamada do posto externo é avisada aos derivados através de um beep repetido a cada 5”.

3 beep seguidos indicam que não é possível efectuar chamadas porque a linha é ocupada.

### Transferência de chamada

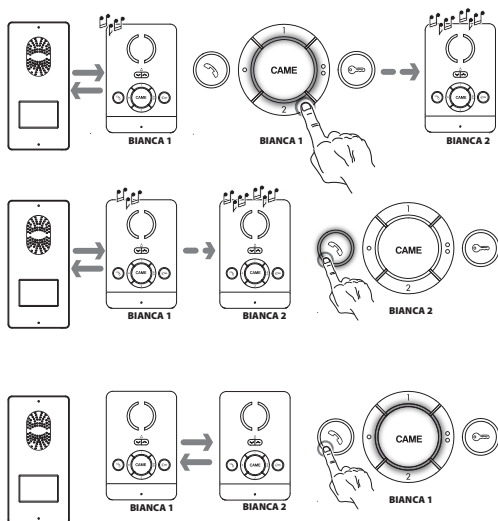

Com uma comunicação activa, seleccione o número interno ao que se queira transferir a chamada (o derivado chamante soará um toque de linha livre, enquanto que o derivado chamado soará com um toque escolhido). Para activar a comunicação audio é necessário premer a tecla  do derivado chamado.

Uma vez efectuada a conexão audio com o interno desejado, prema  para transferir a chamada. O interno que recebe a chamada poderá retransmiti-la.

## Funções de Portaria



As funções descritas neste parágrafo estão disponíveis somente em instalações dotadas de local para portaria.

### Chamada do porteiro

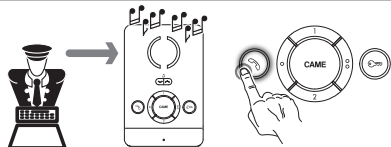

Prema o botão para responder

### Aviso de chamada do porteiro

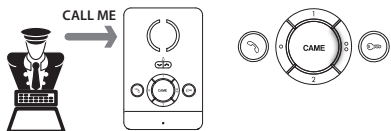

O aviso é assinalado através da iluminação do LED Aux2 . O LED apaga-se quando se entra em comunicação com o porteiro.

### Pedido de chamada ao porteiro

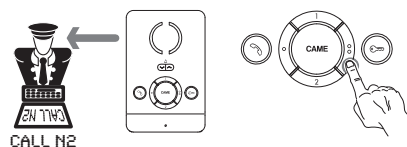

Pedido de chamada ao porteiro

## PROGRAMAÇÃO

Para a programação da chamada, consulte a documentação dos pontos externos.

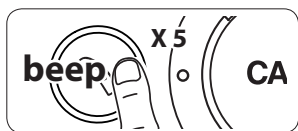

①



**Entrada em programação.** Prema 5 vezes o botão dentro de 5 s. Um breve aviso sonoro confirma a entrada em programação ①.



②



**Programação da melodia associada à chamada do posto externo (1 aviso sonoro).** Para sentir as melodias em sequência, preme o botão ②. Para escolher a melodia e sair da programação preme a tecla ③. Para escolher a melodia e continuar a programação preme a tecla ④.

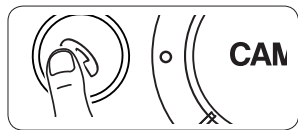

③



**Programação da melodia associada à chamada do patamar (2 avisos sonoros).** Para este tipo de programação ② ③ ④ proceda como a "Programação da melodia associada à chamada do posto externo" anteriormente descrita.

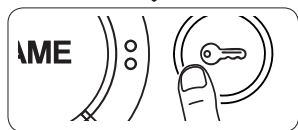

④

**Programação do número de toques da chamada (3 avisos sonoros).** Prema a tecla o número de vezes dos toques que se queira para a chamada (de 1 a 6 toques) ⑤. 3 s da última pressão da tecla será indicada a chamada seleccionada para o número de toques predefinido. Para escolher a melodia e sair da programação preme a tecla ⑥.



⑤



⑥



**ℹ Para a limpeza utilize somente panos macios e secos ou um pouco húmidos; não utilize nenhum tipo de produto químico.**

## **ELIMINAÇÃO**

Certifique-se que o material de embalagem não seja deixado no ambiente, mas sim eliminado de acordo com as normas vigentes no país de utilização do produto.

No fim do ciclo de vida do aparelho, evite que o mesmo seja deixado no meio ambiente.

A eliminação do aparelho deve ser feita de acordo com as normas vigentes e dando prioridade à reciclagem das partes que o constituem.

Nos componentes, para os quais é prevista a eliminação com reciclagem, encontram-se o símbolo e a sigla do material.



**DEZE GEBRUIKSAANWIJZING MOET SAMEN MET HET APPARAAT WORDEN GELEVERD**

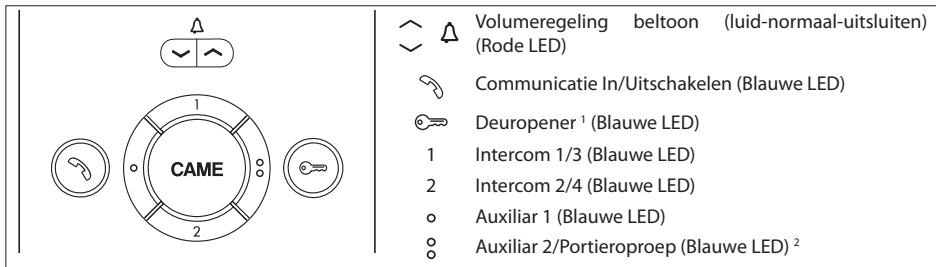

1 In systemen die met deze functie zijn uitgerust, signaleert een ononderbroken brandende LED tijdens een oproep van de buitenpost dat de deur open is.

2 Deze functie kan ook ter beschikking zijn als de communicatie niet actief is, als het systeem daarvoor is gemaakt.

**Basisfuncties**

**Een oproep beantwoorden**

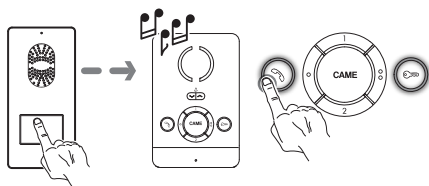

Een oproep beantwoorden

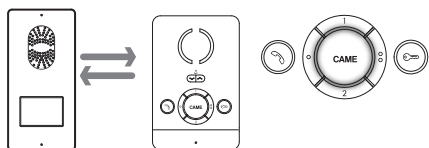

Communicatie actief

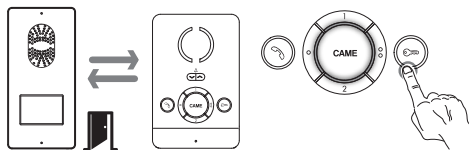

Deuropener van de buitenpost

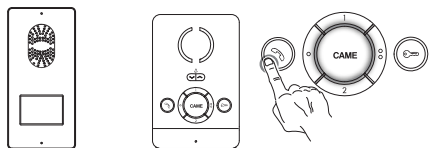

De communicatie beëindigen

**Functies die actief zijn tijdens een oproep**

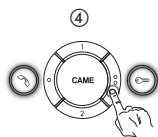
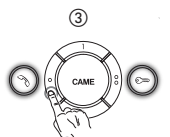
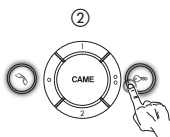
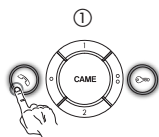

Communicatie inschakelen ①, deur van geselecteerde buitenpost openen ② en extra commando's inschakelen ③ ④.

## De beltoon uitschakelen



Om de beltoon uit te schakelen, drukt u op de toets  totdat de LED gaat branden. De beltoon is uitgeschakeld voor alle oproepen. Druk op de knop  om het volume van de beltoon opnieuw te regelen.

## Interne communicatie

### Oproepen aan interne apparaten

#### INTERCOM 1/3

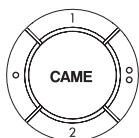

Om de interne apparaten 1 en 2 (3 of 4) op te bellen, drukt u op de bijbehorende knoppen.

#### INTERCOM 2/4

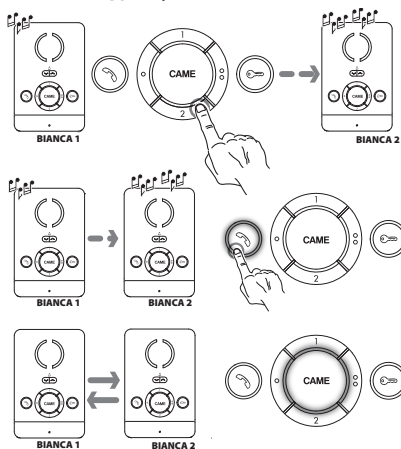

Als het gewenste interne apparaat is geselecteerd, laat het oproepende apparaat het signaal "lijn vrij" horen, terwijl het opgeroepen apparaat rinkelt met de geselecteerde beltoon.

Om de audio in te schakelen, moet de toets ingedrukt worden  van het opgeroepen interne apparaat.

Tijdens een gesprek tussen interne apparaten, wordt een oproep door een buitenpost signaleerd aan de interne apparaten met een bieptoon die om de 5" wordt herhaald.

3 opeenvolgende bieptonen betekenen dat een oproep onmogelijk is omdat de lijn bezet is.

### Een oproep doorschakelen

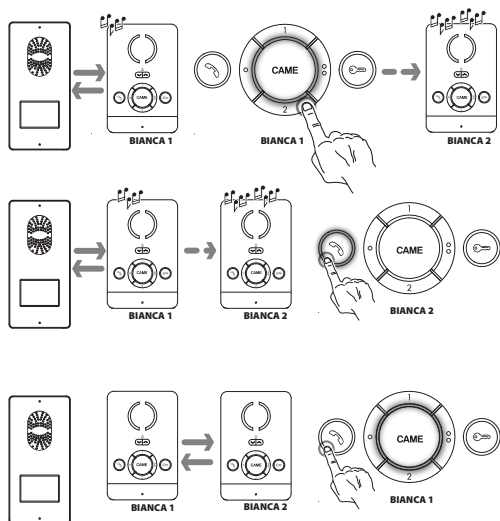

Terwijl de communicatie ingeschakeld is, selecteert u het interne apparaat waarnaar u de oproep wenst door te schakelen (het oproepende apparaat laat het signaal "lijn vrij" horen, terwijl het opgeroepen apparaat rinkelt met de geselecteerde beltoon). Om de audio in te schakelen, moet op het opgeroepen apparaat de toets  ingedrukt worden.

Zodra de audioverbinding met het gewenste interne apparaat tot stand is gebracht, drukt men op de toets  om de oproep door te schakelen. Het interne apparaat dat de oproep ontvangt, kan deze ook weer doorschakelen.

## Portiersfuncties



De functies die zijn beschreven in de onderhavige paragraaf zijn alleen beschikbaar in systemen met een portierspost.

### Oproep door de portier

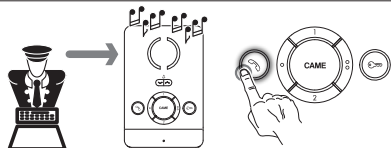

Druk op de knop om de oproep te beantwoorden.

### Melding van oproep door portier

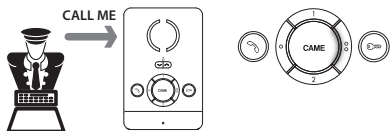

De oproep wordt gesignaleerd met de LED Aux2 die gaat branden . De LED gaat uit als u de communicatie met de portier tot stand brengt.

### Oproep aan de portier

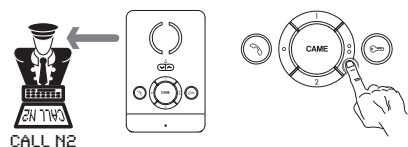

Oproep aan de portier

## PROGRAMMEREN

Op de oproep te programmeren, leest u de documentatie van de buitenposten.

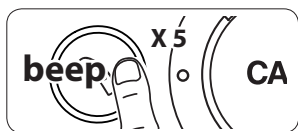

①



②

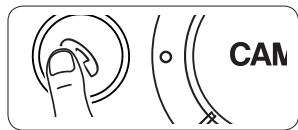

③

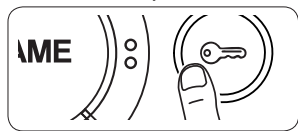

④

**Te programmeren ingang** Druk binnen 5 seconden 5 keer op . Een kort akoestisch signaal bevestigt de ingang die wordt geprogrammeerd ①.

**De beltoon programmeren voor de oproepen van de buitenpost (1 akoestisch signaal).** Om de beltonen achter elkaar te beluisteren, drukt u op de toets ②. Om de beltoon te kiezen en het programmeren te sluiten, drukt u op ③. Om de beltoon te kiezen en iets anders te programmeren, drukt u op ④.

**De beltoon programmeren voor de oproepen aan de huisdeur (2 akoestische signalen).** Voor deze configuratie ② ③ ④ gaat u te werk zoals beschreven in "De beltoon programmeren voor de oproepen van de buitenpost".

**Het aantal rinkeltonen programmeren (3 akoestische signalen).** Druk net zo vaak op de toets als het aantal rinkeltonen dat u wenst voor de oproep (van 1 tot 6) ⑤. 3 s na de laatste druk op de toets hoort u de beltoon die gekozen is voor het ingestelde aantal rinkeltonen. Om de beltoon te kiezen en het programmeren te sluiten, drukt u op ⑥.



⑤



⑥

**!** Reinig het apparaat alleen met een zachte droge doek of een lichtjes met water bevochtigde doek; gebruik geen chemische producten.

### **SLOOPAFVAL**

Zorg ervoor dat het verpakkingsafval niet in het milieu terecht komt maar wordt verwerkt volgens de voorschriften voor afval die gelden in het land van gebruik van het product.

Aan het einde van zijn levenscyclus zorgt u ervoor dat het apparaat het milieu niet kan vervuilen.

Verwerk het afgedankte apparaat volgens de geldende voorschriften en tracht de onderdelen ervan te recyclen. Op de onderdelen die geschikt zijn voor recyclage staat het symbool en de afkorting van het materiaal.







**CAME**



CAME Group S.p.A  
Viale delle Industrie, 89/c  
31030 Dosson di Casier-TREVISO-Italy  
[www.came.it-info@came.it](http://www.came.it-info@came.it)