



Wireless PIR Detector

User's Manual



Foreword

General





This manual introduces the installation, functions and operations of the Wireless PIR Detector (hereinafter referred to as the "PIR"). Read carefully before using the device, and keep the manual safe for future reference.

Model

DHI-ARD1233-W2(868); DHI-ARD1233-W2

Safety Instructions

The following signal words might appear in the manual.

| Signal Words | Meaning |
|--|--|
|  DANGER | Indicates a high potential hazard which, if not avoided, will result in death or serious injury. |
|  WARNING | Indicates a medium or low potential hazard which, if not avoided, could result in slight or moderate injury. |
|  CAUTION | Indicates a potential risk which, if not avoided, could result in property damage, data loss, reductions in performance, or unpredictable results. |
|  TIPS | Provides methods to help you solve a problem or save time. |
|  NOTE | Provides additional information as a supplement to the text. |

Revision History

| Version | Revision Content | Release Time |
|---------|---|---------------|
| V2.0.1 | Updated the description for detector test. | November 2022 |
| V2.0.0 | Updated the description for 24 h protection zone. | August 2022 |
| V1.1.0 | <ul style="list-style-type: none"> Added technical specifications and field of view. Updated descriptions of parameters. Updated images. | January 2022 |
| V1.0.0 | First release. | October 2021 |

Privacy Protection Notice

As the device user or data controller, you might collect the personal data of others such as their face, fingerprints, and license plate number. You need to be in compliance with your local privacy protection laws and regulations to protect the legitimate rights and interests of other people by implementing measures which include but are not limited: Providing clear and visible identification to inform people of the existence of the surveillance area and provide required contact information.

About the Manual

- The manual is for reference only. Slight differences might be found between the manual and the product.
- We are not liable for losses incurred due to operating the product in ways that are not in compliance with the manual.
- The manual will be updated according to the latest laws and regulations of related jurisdictions. For detailed information, see the paper user's manual, use our CD-ROM, scan the QR code or visit our official website. The manual is for reference only. Slight differences might be found between the electronic version and the paper version.
- All designs and software are subject to change without prior written notice. Product updates might result in some differences appearing between the actual product and the manual. Please contact customer service for the latest program and supplementary documentation.
- There might be errors in the print or deviations in the description of the functions, operations and technical data. If there is any doubt or dispute, we reserve the right of final explanation.
- Upgrade the reader software or try other mainstream reader software if the manual (in PDF format) cannot be opened.
- All trademarks, registered trademarks and company names in the manual are properties of their respective owners.
- Please visit our website, contact the supplier or customer service if any problems occur while using the device.
- If there is any uncertainty or controversy, we reserve the right of final explanation.

Important Safeguards and Warnings

This section introduces content covering the proper handling of the PIR, hazard protection, and protection of property damage. Read carefully before using the PIR, and comply with the guidelines when using it.

Operation Requirements



- Make sure that the power supply of the PIR works properly before use.
- Do not pull out the power cable of the PIR while it is powered on.
- Only use the PIR within the rated power range.
- Transport, use and store the device under allowed humidity and temperature conditions.
- Prevent liquids from splashing or dripping on the device. Make sure that there are no objects filled with liquid on top of the PIR to avoid liquids flowing into it.
- Do not disassemble the PIR.

Installation Requirements



WARNING

- Connect the PIR to the adapter before power on.
- Strictly abide by local electrical safety standards, and make sure that the voltage in the area is steady and conforms to the power requirements of the PIR.
- Do not connect the PIR to more than one power supply. Otherwise, the PIR might become damaged.



- Observe all safety procedures and wear required protective equipment provided for your use while working at heights.
- Do not expose the PIR to direct sunlight or heat sources.
- Do not install the PIR in humid, dusty or smoky places.
- Install the PIR in a well-ventilated place, and do not block the ventilator of the device.
- Use the power adapter or case power supply provided by the device manufacturer.
- The power supply must conform to the requirements of ES1 in IEC 62368-1 standard and be no higher than PS2. Note that the power supply requirements are subject to the device label.
- Connect class I electrical appliances to a power socket with protective earthing.

Table of Contents

| | |
|---|-----|
| Foreword | I |
| Important Safeguards and Warnings | III |
| 1 Introduction | 1 |
| 1.1 Overview | 1 |
| 1.2 Technical Specifications | 1 |
| 2 Checklist | 4 |
| 3 Design | 5 |
| 3.1 Appearance | 5 |
| 3.2 Dimensions | 5 |
| 4 Adding the PIR to the Hub | 6 |
| 5 Installation | 7 |
| 5.1 Field of View | 7 |
| 5.2 Installing the PIR | 7 |
| 6 Configuration | 10 |
| 6.1 Viewing Status | 10 |
| 6.2 Configuring the PIR | 11 |
| Appendix 1 Cybersecurity Recommendations | 14 |

1 Introduction

1.1 Overview

Wireless PIR detector is a wireless motion detector designed for indoor use. It can detect a human moving within 12 m of the detector. It can be set up via the DMSS App for iOS and Android phones.

1.2 Technical Specifications

This section contains technical specifications of the PIR. Please refer to the ones that correspond with your model.

Table 1-1 Technical specifications

| Type | Parameter | Description | |
|---------------------|-------------------------|--|---|
| Port | Indicator Light | 1 × green alarm indicator | |
| | Button | 1 × power button | |
| Function | Tamper Alarm | Yes | |
| | Remote Update | Cloud update | |
| | Search | Signal strength detection | |
| | Low Battery Alarm | Yes | |
| Wireless Parameters | Carrier Frequency | DHI-ARD1233-W2(868): 868.0 MHz–868.6 MHz | DHI-ARD1233-W2: 433.1 MHz–434.6 MHz |
| | Transmission Power | DHI-ARD1233-W2(868): Limit 25 mW | DHI-ARD1233-W2: Limit 10 mW |
| | Communication Distance | DHI-ARD1233-W2(868): Up to 1,600 m (5,249.34 ft) in an open space | DHI-ARD1233-W2: Up to 1,200 m (3,937.01 ft) in an open space |
| | Communication Mechanism | Two-way | |
| | Encryption Mode | AES128 | |
| | Frequency Hopping | Yes | |
| Temperature | Measuring Range | Indoor: –15 °C to +65 °C (+18.8 °F to +149 °F) | |
| | Measuring Precision | ± 1 °C (± 33.8 °F) | |
| | Resolution | 1 °C (33.8 °F) | |
| Technical Parameter | Detection Mode | PIR | |
| | Sensor | Dual-element low-noise PIR sensor | |
| | Test Mode | Yes | |

| Type | Parameter | Description | |
|--------------|--|--|-------------------------------|
| | Detection Range | 12 m (39.37 ft) (90°) with installation height of 2.2 m (7.21 ft) | |
| | Detection Speed | 0.3 m/s–3 m/s (0.98 ft/s–9.84 ft/s) | |
| | Pet Immunity Level | ≤ 18 kg (39.68 lb) | |
| | White Light Resistance Level | 2000 lx | |
| | Two-way Digital Temperature Compensation | Yes, no attenuation of detection distance in high temperature | |
| | Sensitivity | 3 levels adjustable | |
| General | Power Supply | CR123A battery | |
| | Battery Voltage | 3 VDC | |
| | Min. Voltage | 1.8 VDC | |
| | Battery Low Threshold | 2.7 VDC | |
| | Battery Restore Threshold | 2.75 VDC | |
| | Typical Voltage | 3 VDC | |
| | Low Voltage Value | 2.7 VDC | |
| | Consumption | Quiescent current 9 uA Max. current 60 mA | |
| | PS Type | Type C | |
| | Battery Life | 4 years | |
| | Power Consumption | DHI-ARD1233-W2(868): Max. 120 mW | DHI-ARD1233-W2: Max. 75 mW |
| | Operating Environment | Indoor: –10 °C to +55 °C (+14 °F to +131 °F) Certified temperature: –10°C to +40°C (+14°F to +104 °F) | |
| | Operating Humidity | 10%–90% (RH) | |
| | Product Dimensions | 104.0 mm× 60.0 mm× 50.0 mm (4.09" × 2.36" × 1.97") | |
| | Packaging Dimensions | 135.0 mm× 98.5 mm× 56.8 mm (5.31" × 3.88" × 2.24") | |
| | Installation | Wall mount | |
| Net Weight | 100 g (0.22 lb) | | |
| Gross Weight | 170 g (0.37 lb) | | |
| Casing | PC + ABS | | |

| Type | Parameter | Description |
|----------------|--|--|
| Certifications | DHI-ARD1233-W2(868): <ul style="list-style-type: none">• EN 50131-1: 2006+A2:2017 + A3:2020• EN 50131-2-2: 2017• EN 50131-5-3: 2017• EN 50131-6:2017• Security Grade (SG) 2• Environmental Class (EC) II• CE | DHI-ARD1233-W2: <ul style="list-style-type: none">• CE• FCC |

2 Checklist

Figure 2-1 Checklist

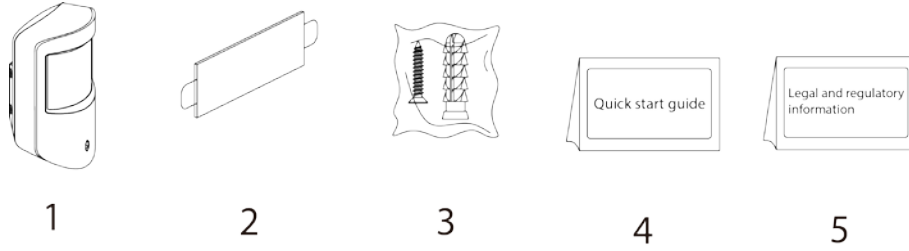

Table 2-1 Checklist

| No. | Item Name | Quantity | No. | Item Name | Quantity |
|-----|----------------------------|----------|-----|----------------------------------|----------|
| 1 | PIR | 1 | 4 | Quick start guide | 1 |
| 2 | Double-sided adhesive tape | 1 | 5 | Legal and regulatory information | 1 |
| 3 | Screw package | 1 | — | — | — |

3 Design

3.1 Appearance

Figure 3-1 Appearance

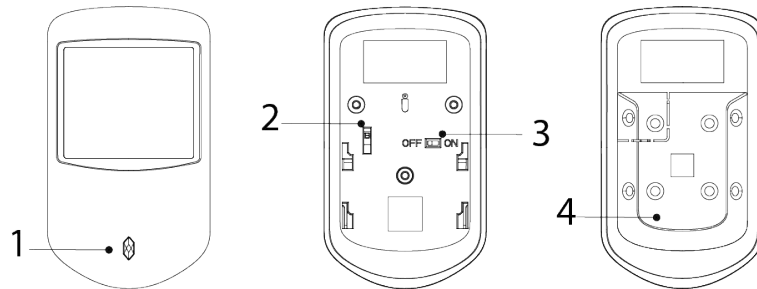
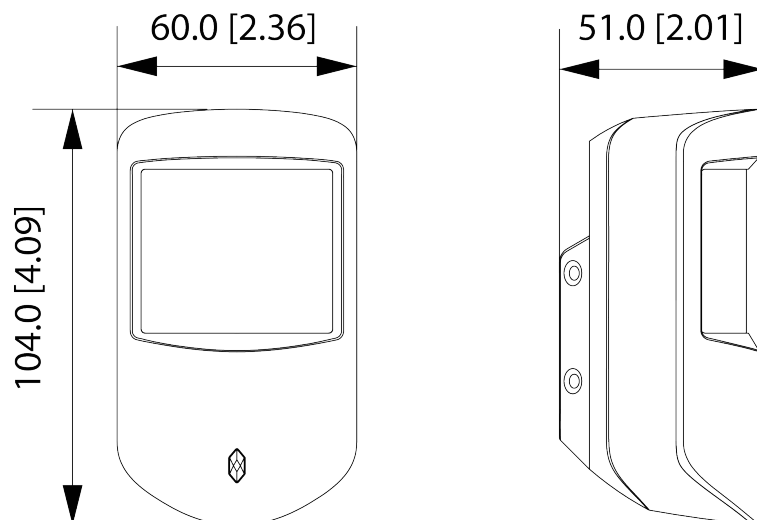

Table 3-1 Structure

| No. | Name | Description |
|-----|---------------|--|
| 1 | Indicator | <ul style="list-style-type: none"> Flashes green quickly: Pairing mode or reduced sensitivity mode. Solid green: Alarm event was triggered. Solid green for 2 seconds: Pairing successful. Slowly flashes green for 3 seconds: Pairing failed. |
| 2 | On/Off switch | Turn on or turn off the PIR. |
| 3 | Tamper switch | When the tamper switch is released, the tamper alarm will be triggered. |
| 4 | Back cover | If the back cover is opened, the tamper alarm will be triggered. |

3.2 Dimensions

Figure 3-2 Dimensions (mm [inch])



4 Adding the PIR to the Hub

Before you connect PIR to the hub, install the DMSS app to your phone. This manual uses iOS as an example.



- Make sure that the version of the DMSS app is 1.91 or later, and the hub is V1.001.0000000.0.R.210303 or later.
- Make sure that you have already created an account, and added the hub to DMSS.
- Make sure that the hub has a stable internet connection.
- Make sure that the hub is disarmed.

Step 1 Go to the hub screen, and then tap **Peripheral** to add the PIR.

Step 2 Tap **+** to scan the QR code at the bottom of the PIR, and then tap **Next**.

Step 3 Tap **Next** after the PIR has been found.

Step 4 Follow the on-screen instructions and switch the PIR to on, and then tap **Next**.

Step 5 Wait for the pairing.

Step 6 Customize the name of the PIR, and select the area, and then tap **Completed**.

5 Installation

5.1 Field of View

Field of view of the PIR is shown below.



When installing and using the PIR, make sure there are no objects partially or fully obscuring the detector's field of view.

Figure 5-1 Field of view

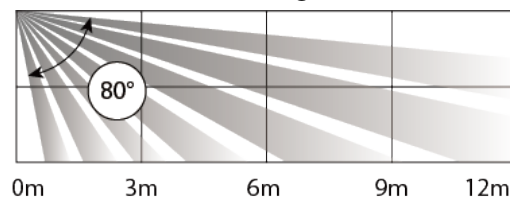

a

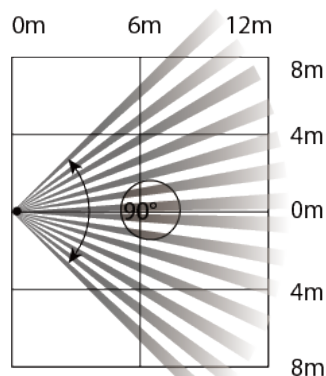

b

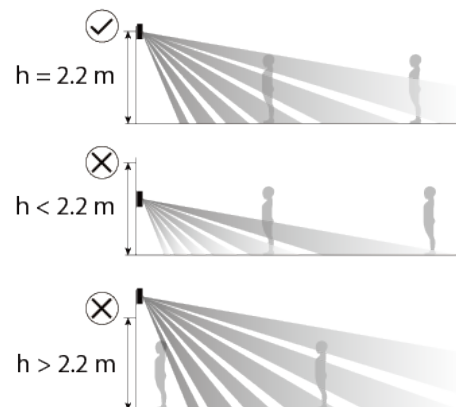

c

5.2 Installing the PIR

Prerequisites

Before installation, add the PIR to the hub and check the signal strength of the installation location. We recommend installing the PIR in a place with a signal strength of at least 2 bars.

Background Information

The PIR supports wall mount.

Figure 5-2 Installation location

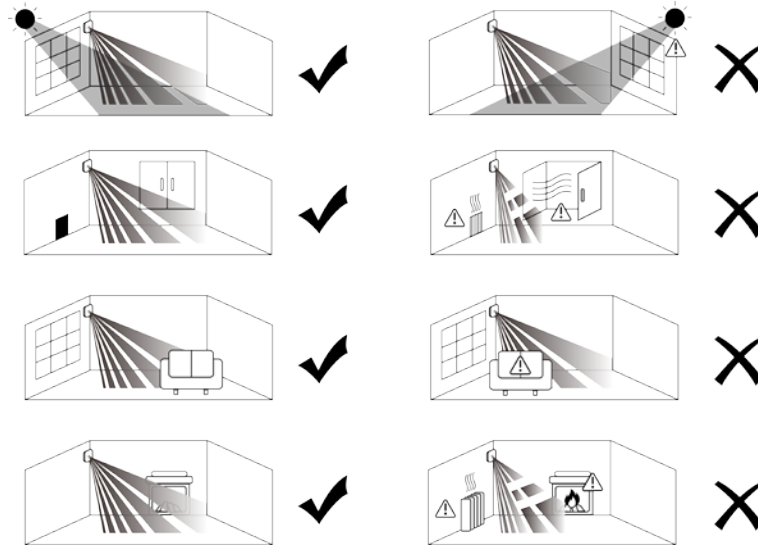

Procedure

Step 1 Remove the back cover of the PIR.

Figure 5-3 Remove the back cover

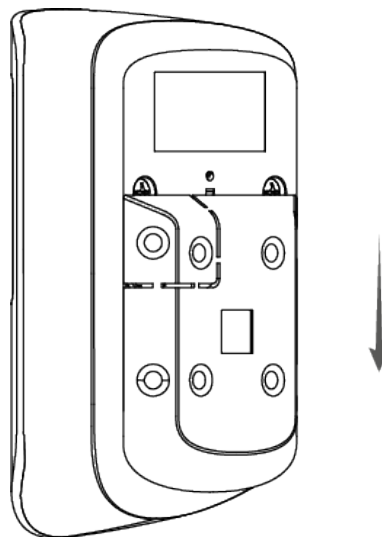

Step 2 Drill four holes into the wall according to the hole positions of the PIR, and then put the expansion bolts into the holes.

Figure 5-4 Drill holes

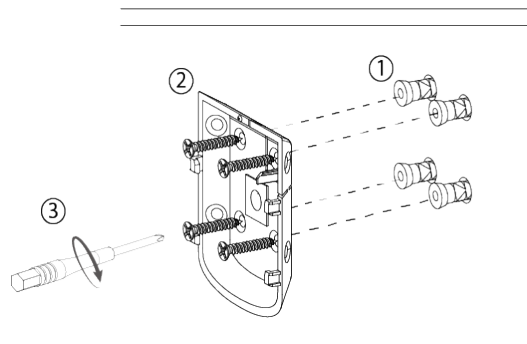

Step 3 Attach the PIR to the back cover.

Figure 5-5 Attach the PIR to the back cover

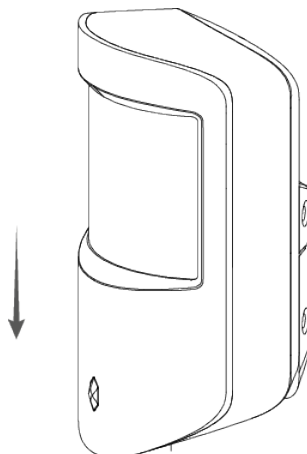

















6 Configuration

You can view and edit general information of the PIR.

6.1 Viewing Status

On the hub screen, select a PIR from the peripheral list, and then you can view the status of the PIR.

Table 6-1 Status

| Parameter | Description |
|-----------------------|---|
| Temporary Deactivate | <p>The status for whether the functions of the PIR are enabled or disabled.</p> <ul style="list-style-type: none"> ●  : Enable. ●  : Only disable tamper alarm. ●  : Disable. <p></p> <p>The function is only available when the version of the DMSS app is 1.96 or later, the hub is V1.001.0000000.6.R.211215 or later, and the PIR is V1.000.0000001.0.R.20211203 or later.</p> |
| Temperature | The temperature of the environment. |
| Signal Strength | <p>The signal strength between the hub and the PIR.</p> <ul style="list-style-type: none"> ●  : Low. ●  : Weak. ●  : Good. ●  : Excellent. ●  : No. |
| Battery Level | <p>The battery level of the PIR.</p> <ul style="list-style-type: none"> ●  : Fully charged. ●  : Sufficient. ●  : Moderate. ●  : Insufficient. ●  : Low. |
| Anti-tampering Status | Anti-tampering status of the PIR. |
| Online Status | <p>Online and offline status of the PIR.</p> <ul style="list-style-type: none"> ●  : Online. ●  : Offline. |
| Entrance Delay Time | Entrance and exit delay time. |
| Exit Delay Time | |
| Sensitivity | Sensitivity level during a shock alarm. |





| Parameter | Description |
|-----------------------------|---|
| 24 H Protection Zone Status | Active status of the 24 h protection zone. <ul style="list-style-type: none"> ● : Enabled. ● : Disabled. |
| Relay Status | The status of whether the PIR forwards its messages to the hub through the repeater. The function is only available when the version of the DMSS app is 1.96 or later, the hub is V1.001.0000000.6.R.211215 or later, and the PIR is V1.000.0000001.0.R.20211203 or later. |
| Program Version | The program version of PIR. |



6.2 Configuring the PIR

On the hub screen, select a PIR from the peripheral list, and then tap to configure the parameters of the PIR.

Table 6-2 Parameter descriptions

| Parameter | Description |
|----------------------|---|
| Device Configuration | <ul style="list-style-type: none"> ● View PIR name, type, SN and device model. ● Edit PIR name, and then tap Save to save configuration. |
| Area | Select the area to which the PIR is assigned. |
| Temporary Deactivate | <ul style="list-style-type: none"> ● Tap Enable, and then the function of the PIR will be enabled. Enable is set by default. ● Tap Only Disable Tamper Alarm, and then the system will only ignore tamper alarm messages. ● Tap Disable, and then the function of the PIR will be disabled. |
| LED Indicator | <p>LED Indicator is enabled by default. For details on indicator behavior, see "3.1 Appearance".</p> <ul style="list-style-type: none"> ● If LED Indicator is disabled, the LED indicator will remain off regardless of whether the PIR is functioning normally or not. ● The function is only available when the version of the DMSS app is 1.96 or later, the hub is V1.001.0000000.4.R.211014 or later, and the PIR is V1.000.0000001.0.R.20210818 or later. |

| Parameter | Description |
|----------------------------|--|
| 24 H Protection Zone | <ul style="list-style-type: none"> • If 24 H Protection Zone is enabled, even the system is disarmed, the PIR can be armed and detects motion. • If 24 H Protection Zone is disabled, only when the system is armed, the PIR can be armed and detects motion. The PIR will not be armed immediately, it will begin before the end of the ping interval of the hub-detector (60 seconds by default).  <p>You can go to the hub's screen to configure the ping interval of the hub-detector. For details, see the user's manual of the hub.</p> |
| Home Mode | Enable the home mode, and then the selected peripherals under the hub will be armed. |
| Delay Mode under Home Mode | Enable the Delay Mode under Home Mode , the selected accessory under the hub will be armed and the alarm will not be triggered until the end of customized delay time.  <p>Only enable Home Mode first can Delay Mode under Home Mode take effect.</p> |
| Delay Time | <ul style="list-style-type: none"> • The system provides you with time to leave or enter the protection zone without alarm. <ul style="list-style-type: none"> ◇ Delay Time for Entering Arming Mode: When you enter the zone, if you do not disarm the system before the delay ends, an alarm will be triggered.  <p>Make sure that the delay time for entering arming mode is no longer than 45 seconds in order to comply with EN50131-1.</p> <ul style="list-style-type: none"> ◇ Delay Time for Exiting Arming Mode: When you are in the zone and arm the system, if you do not leave the zone before the delay ends, an alarm will be triggered. <ul style="list-style-type: none"> • Select from 0 s to 120 s.  <p>The arming mode will be effective after the delay time.</p> |
| Sensitivity | <ul style="list-style-type: none"> • Sensitivity level during a shock alarm. • Select from low, medium and high. |
| Siren Linkage | When an alarm is triggered, the accessories will report the alarm events to the hub and alert with siren. |
| Alarm-video Linkage | When an alarm is triggered, the accessories will report the alarm events to the hub and then will be linked with videos. |

| Parameter | Description |
|---------------------------|--|
| Video Channel | Select the video channel as needed. |
| Signal Strength Detection | Test the current signal strength. |
| Detector Test | <p>Tap Start Detection to test the status of the detector.</p>  <ul style="list-style-type: none"> The detector test will not begin immediately. it will begin before the end of the ping interval of the hub-detector (60 seconds by default). You can configure the hub-detector ping interval on the hub. |
| Transmit Power | <ul style="list-style-type: none"> Select from high, low, and automatic. The higher the transmission power, the farther the signal can travel, but the greater the power consumption.  <ul style="list-style-type: none"> If you select Low, and then the PIR will enter reduced sensitivity mode until you select another option. The reduced sensitivity mode is only available when the version of the DMSS app is 1.97 or later, the hub is V1.001.0000000.6.R.211228 or later, and the PIR is V1.000.0000001.0.R.20211203 or later. |
| Cloud Update | Update online. |
| Delete | <p>Delete the PIR.</p>  <p>Go to the hub screen, select the PIR from the list, and then swipe left to delete it.</p> |

Appendix 1 Cybersecurity Recommendations

Cybersecurity is more than just a buzzword: it's something that pertains to every device that is connected to the internet. IP video surveillance is not immune to cyber risks, but taking basic steps toward protecting and strengthening networks and networked appliances will make them less susceptible to attacks. Below are some tips and recommendations from Dahua on how to create a more secured security system.

Mandatory actions to be taken for basic device network security:

1. Use Strong Passwords

Please refer to the following suggestions to set passwords:

- The length should not be less than 8 characters.
- Include at least two types of characters; character types include upper and lower case letters, numbers and symbols.
- Do not contain the account name or the account name in reverse order.
- Do not use continuous characters, such as 123, abc, etc.
- Do not use overlapped characters, such as 111, aaa, etc.

2. Update Firmware and Client Software in Time

- According to the standard procedure in Tech-industry, we recommend to keep your device (such as NVR, DVR, IP camera, etc.) firmware up-to-date to ensure the system is equipped with the latest security patches and fixes. When the device is connected to the public network, it is recommended to enable the "auto-check for updates" function to obtain timely information of firmware updates released by the manufacturer.
- We suggest that you download and use the latest version of client software.

"Nice to have" recommendations to improve your device network security:

1. Physical Protection

We suggest that you perform physical protection to device, especially storage devices. For example, place the device in a special computer room and cabinet, and implement well-done access control permission and key management to prevent unauthorized personnel from carrying out physical contacts such as damaging hardware, unauthorized connection of removable device (such as USB flash disk, serial port), etc.

2. Change Passwords Regularly

We suggest that you change passwords regularly to reduce the risk of being guessed or cracked.

3. Set and Update Passwords Reset Information Timely

The device supports password reset function. Please set up related information for password reset in time, including the end user's mailbox and password protection questions. If the information changes, please modify it in time. When setting password protection questions, it is suggested not to use those that can be easily guessed.

4. Enable Account Lock

The account lock feature is enabled by default, and we recommend you to keep it on to guarantee the account security. If an attacker attempts to log in with the wrong password several times, the corresponding account and the source IP address will be locked.

5. Change Default HTTP and Other Service Ports

We suggest you to change default HTTP and other service ports into any set of numbers between

1024–65535, reducing the risk of outsiders being able to guess which ports you are using.

6. **Enable HTTPS**

We suggest you to enable HTTPS, so that you visit Web service through a secure communication channel.

7. **MAC Address Binding**

We recommend you to bind the IP and MAC address of the gateway to the device, thus reducing the risk of ARP spoofing.

8. **Assign Accounts and Privileges Reasonably**

According to business and management requirements, reasonably add users and assign a minimum set of permissions to them.

9. **Disable Unnecessary Services and Choose Secure Modes**

If not needed, it is recommended to turn off some services such as SNMP, SMTP, UPnP, etc., to reduce risks.

If necessary, it is highly recommended that you use safe modes, including but not limited to the following services:

- SNMP: Choose SNMP v3, and set up strong encryption passwords and authentication passwords.
- SMTP: Choose TLS to access mailbox server.
- FTP: Choose SFTP, and set up strong passwords.
- AP hotspot: Choose WPA2-PSK encryption mode, and set up strong passwords.

10. **Audio and Video Encrypted Transmission**

If your audio and video data contents are very important or sensitive, we recommend that you use encrypted transmission function, to reduce the risk of audio and video data being stolen during transmission.

Reminder: encrypted transmission will cause some loss in transmission efficiency.

11. **Secure Auditing**

- Check online users: we suggest that you check online users regularly to see if the device is logged in without authorization.
- Check device log: By viewing the logs, you can know the IP addresses that were used to log in to your devices and their key operations.

12. **Network Log**

Due to the limited storage capacity of the device, the stored log is limited. If you need to save the log for a long time, it is recommended that you enable the network log function to ensure that the critical logs are synchronized to the network log server for tracing.

13. **Construct a Safe Network Environment**

In order to better ensure the safety of device and reduce potential cyber risks, we recommend:

- Disable the port mapping function of the router to avoid direct access to the intranet devices from external network.
- The network should be partitioned and isolated according to the actual network needs. If there are no communication requirements between two sub networks, it is suggested to use VLAN, network GAP and other technologies to partition the network, so as to achieve the network isolation effect.
- Establish the 802.1x access authentication system to reduce the risk of unauthorized access to private networks.
- Enable IP/MAC address filtering function to limit the range of hosts allowed to access the

device.

More information

Please visit Dahua official website security emergency response center for security announcements and the latest security recommendations.

ENABLING A SAFER SOCIETY AND SMARTER LIVING

ZHEJIANG DAHUA VISION TECHNOLOGY CO., LTD.

Address: No.1199 Bin'an Road, Binjiang District, Hangzhou, P. R. China | Website: www.dahuasecurity.com | Postcode: 310053

Email: overseas@dahuatech.com | Fax: +86-571-87688815 | Tel: +86-571-87688883