

Line Interactive UPS

PowerWalker VI 500T/HID

PowerWalker VI 750T/HID

PowerWalker VI 1000T/HID

PowerWalker VI 1500T/HID



Quick Start Guide

EN

CONTENT

IMPORTANT SAFETY INSTRUCTIONS	1
1. Introduction	4
2. Description of Features.....	4
3. Package Contents	4
4. Product Overview	5
5. Installation and Initial Startup.....	7
6. Functions & Operation	10
7. Software Installation on your PC	11
8. Maintenance	12
9. Trouble Shooting.....	14
10. Specifications	15

IMPORTANT SAFETY INSTRUCTIONS

SAVE THESE INSTRUCTIONS – This manual contains important instructions for models PowerWalker VI 500T/HID, 750T/HID, 1000T/HID, 1500T/HID that should be followed during installation and maintenance of the UPS and batteries.

- This product is specially designed for PCs and it is not recommended for use in any medical equipment, life-supporting system and other specific important equipment.
- Do not plug household appliances such as hair dryers, microwave ovens or vacuum cleaners to UPS.
- Do not attach a power strip or surge suppressor to the UPS.
- Do not plug the UPS into its own output.
- Connection to any other type of receptacle other than two-pole, three-wire grounded receptacle may result in shock hazard as well as violate local electrical codes.
- To reduce risk of overheating the UPS, do not cover the UPS' cooling vents.
- This unit intended for installation in a controlled environment (temperature controlled, indoor area free of conductive contaminants). Avoid installing the UPS in locations where there is standing or running water or excessive humidity and do not use it in any of the following environments:
 - Any area with combustible gas, corrosive substance or heavy dust.
 - Any area with extraordinarily high or low temperature (above 40°C or below 0°C) and humidity of more than 90%.
 - Any area exposed to direct sunshine or near any heating apparatus.
 - Any area with serious vibrations.
 - Outdoor.
- The utility power outlet shall be near the equipment and easily accessible. In the event of an emergency, press OFF button and disconnect the power cord from the AC power supply to properly disable the UPS.

- The internal short circuiting of the UPS will lead to dangers such as electric shock or fire; therefore do not allow liquids or any foreign object to enter the UPS. No water containers (such as a water glass) or any other liquid-containing vessels shall be placed on the top of the UPS so as to avoid such dangers as electric shock.
- Please do not use the UPS in excess of the rated load capacity.
- Unplug the UPS prior to cleaning and do not use liquid or spray detergent.
- Risk of electric shock, do not attempt to disassemble the unit. No user serviceable parts inside. Refer servicing to qualified service personnel.
- If UPS is to be stored for a long time, it is recommended to recharge the batteries (by connecting the utility power to UPS, switch “ON”), once a month for 24 hours to avoid a full battery discharge.
- In case smoke is found coming out from the device, please cut off the power supply quickly and contact the distributor.
- The UPS contains one/two large-capacity batteries. So the shell shall not be opened, otherwise such dangers as electric shock will be caused. If any internal overhaul or replacement of the battery is required, please contact the distributor.
- Servicing of batteries should be performed or supervised by personnel knowledgeable of batteries and the required precautions. Keep unauthorized personnel away from batteries.
- A battery can present a risk of electrical shock and high short circuit current. The following precautions should be observed when working on batteries:
 - Remove watches, rings, or other metal objects from the hand.
 - Use tools with insulated handles and wear rubber gloves and boots.
 - Do not lay tools or metal parts on top of batteries.
 - Disconnect charging source prior connecting or disconnecting batteries terminals.
- When replacing batteries, replace with the same type and number of the sealed lead-acid batteries.
- The maximum ambient temperature rating is 40°C.

- Do not dispose of battery or batteries in a fire. The battery may explode.
- Do not open or mutilate the battery or batteries. Released electrolyte is harmful to the skin and eyes. It may be toxic.
- Icon Φ on the rating label stands for phase symbol.
- This pluggable type A equipment with battery already installed by the supplier is operator installable and may be operated by laymen.
- During the installation of this equipment it should be assured that the sum of the leakage currents of the UPS and the connected loads does not exceed 3.5mA.
- Attention, hazardous through electric shock. Also with disconnection of this unit from the mains, hazardous voltage still may be accessible through supply from battery. The battery supply should be therefore disconnected in the plus and minus pole of the battery when maintenance or service work inside the UPS is necessary.
- In the event that there is fire occurring in the vicinity, please use dry-power extinguishers. The use of liquid extinguishers may give rise to the danger of electric shock.

This product complies with the safety and environmental regulations in EU.

If the time arises to throw away your product, please recycle all the components possible. Batteries and rechargeable batteries are not to be disposed in your domestic waste! Please recycle them at your local recycling point. Together we can help to protect the environment.



1. Introduction







PowerWalker VI series is an intelligent and compact line interactive UPS (Uninterruptable Power Supply) which is designed to protect your personal computer or sensitive electronic equipments from all forms of power interference, including complete power failures. It is equipped with many features that allow any attached equipment to operate longer and more reliability.

2. Description of Features

- Easy to use and install utilized microprocessor control to maximize the reliability and efficiency
- Equipped with built-in boost and buck AVR function
- DC Cold start function
- Green Power Function for energy saving
- Auto restart while AC recovery.
- Provides AC Overload protection
- RJ11/RJ45 (in/out) LAN/Modem/Phone line protection

3. Package Contents

You should have received the following items inside of package:

 <p>UPS Unit</p>	 <p>USB Cable</p>	 <p>AC Input Power Cord AC output Power cord</p>
 <p>Software CD</p>	 <p>User Manual</p>	 <p>Warranty Card</p>

4. Product Overview

I: Front Panel:

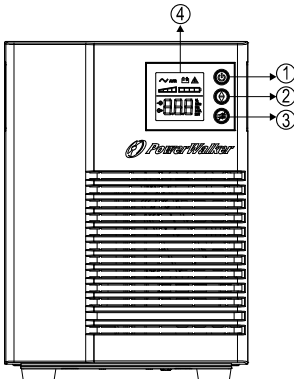

- ❶ ON/OFF button
- ❷ Scroll down button
- ❸ Mute button
- ❹ LCD display

II: Rear Panel:

VI 500T/750T

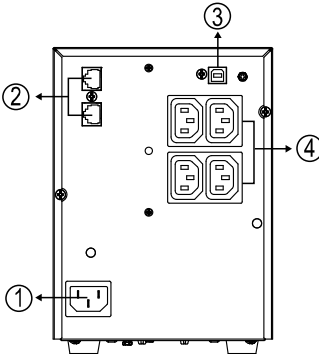

- ❶ AC input
- ❷ RJ11/RJ45 LAN/Modem/phone line protection
- ❸ USB port
- ❹ IEC outlet

VI 1000T/1500T

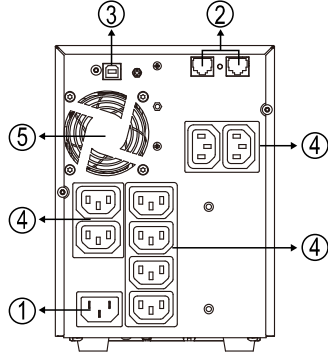

- ❶ AC input
- ❷ RJ11/RJ45 LAN/Modem/phone line protection
- ❸ USB port
- ❹ IEC outlet
- ❺ Fan

III: LCD description:

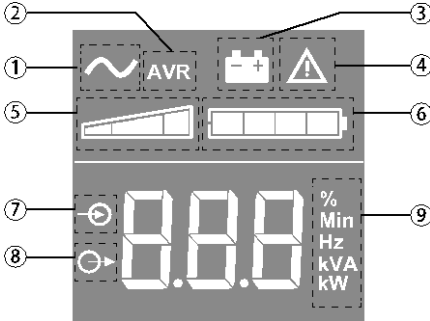

- ① UPS ON
- ② AVR mode
- ③ Battery mode
- ④ Internal fault
- ⑤ Output load level
- ⑥ Battery level
- ⑦ Input measurements
- ⑧ Output measurements
- ⑨ Measuring unit

IV: UPS setting through the LCD:

Release scroll down button to select menu

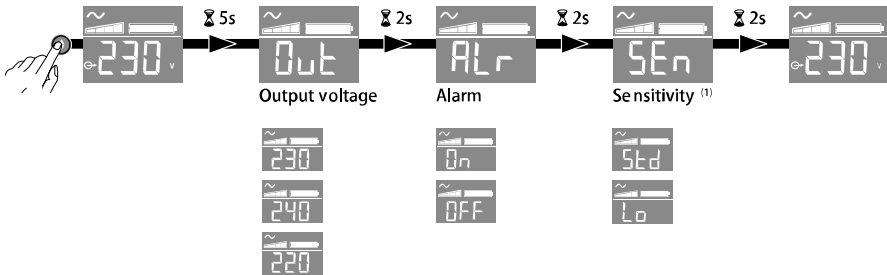

Example of setting

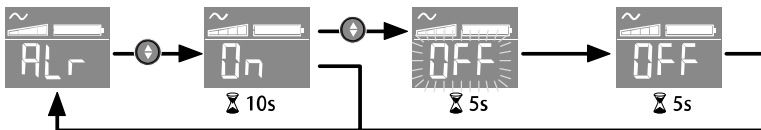

Save the new value

- LCD will shut off if there is no activity for 3 minutes.

(1) In low sensitivity mode (Lo) UPS will tolerate more fluctuations in power and will go on battery power less often. If the connected load is sensitive to power disturbances, keep the sensitivity as Standard (Std).

5. Installation and Initial Startup

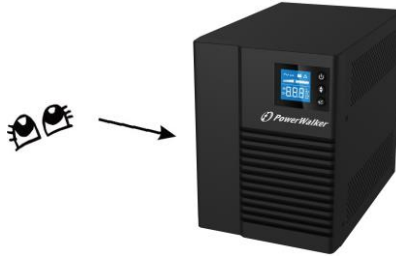

Before installation, please inspect the unit. Be sure that nothing is damaged.

I: Placement & Storage Conditions

Install the UPS in a protected area that is free of excessive dust and has adequate air flow around the unit, and is free from excessive dust, corrosive fumes and conductive contaminants. Please place the UPS away from other units at least 20 cm to avoid interference. Do NOT operate the UPS where the temperature exceeds 0-40° C and the humidity is over 0-90 % RH.

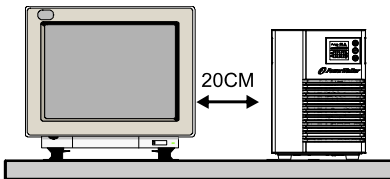

II: Connect to Utility and Charge

Plug in the AC input cord to the 2-pole, 3-wire grounded wall outlet. For the best results, we suggest charging the battery at least 6 hours with no load (no electrical devices such as computers, monitors, etc.) connected before initial use. The unit charges its battery while connecting to the utility.

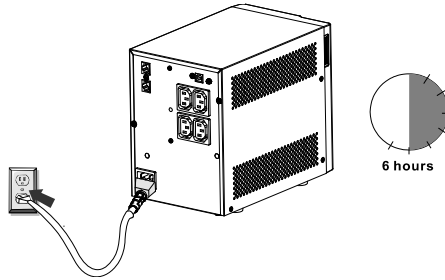

III: Connect the Loads

Plug in the loads to output receptacles on the rear panel of the UPS. Simply turn on the power switch of UPS unit, and devices connected to the UPS will be protected by UPS unit.



Do not attach a power strip or surge suppressor to the UPS.

IV: Connect LAN cable, Modem or Phone line for Surge Protection

Connect for example a single modem or phone line into surge-protected “IN” outlet on the back panel of the UPS unit. Connect from “OUT” outlet to the computer with another phone line cable.

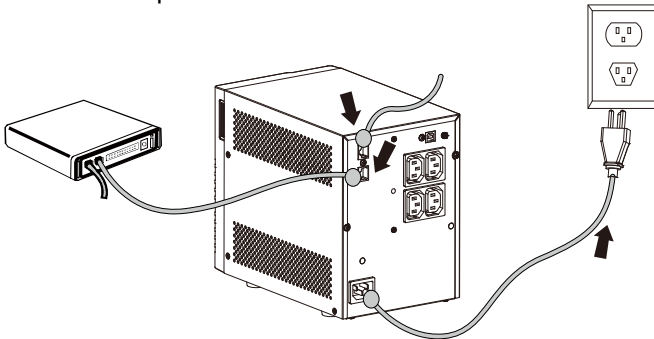

V: Connect USB Cable

To monitor the UPS status, such as unattended UPS shutdown and start-up, by using bundled software, please connect the UPS and PC with USB cable included.

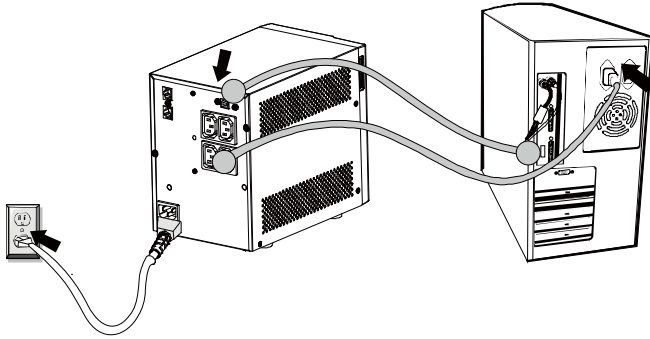

NEVER connect a **laser printer** or **scanner** to the UPS unit, **because in-rush current generated by motor's devices** may cause the damage of the unit.



VI: Turn On/Off the Unit

Turn on the UPS unit by pressing the On/Off button. Turn off the UPS unit by pressing again the On/Off button.

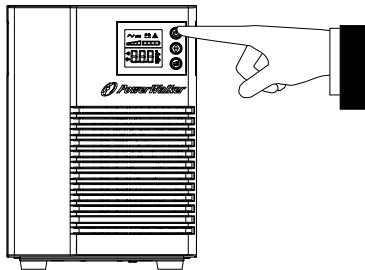

6. Functions & Operation

I: DC Start Function

DC Start Function enables UPS to be started up when AC utility power is not available and battery is fully charged. Just simply press the power switch to turn on the UPS.

II: Green Power Function

These series are equipped with Green Power Function for saving power and protecting battery. The feature of deep discharge protection is adopted on battery mode. If no or light load is connected to the UPS, it will automatically shut down after 5 minutes for energy saving while running on battery mode (Disable by default). The UPS will restart while AC recovery. The green power function can be enable only by Winpower monitoring software.

III: AVR (Automatic Voltage Regulation)

If the quality of the incoming mains is poor, the AVR boosts a low incoming voltage or reduces a high one. The load receives a voltage within the normal range.

IV: Auto restart while AC recovery

V: Audio Indicator

<u>Audible Alarm</u>	<u>Situation</u>
Sounding every 10 seconds	Battery Mode
Sounding every 3 seconds	Battery Low
Sounding every 3 seconds	Overload
Sounding every 1 seconds	Faulty

7. Software Installation on your PC

Connected by USB to a PC or notebook, the Software enables communication between the UPS and the computer. The UPS software monitors the status of the UPS, shuts down the system before the UPS is exhausted and can remotely observe the UPS via the Network (enabling users to manage their system more effectively). Upon AC failure or UPS battery low, UPS takes all necessary actions without intervention from the system administrator. In addition to automatic file saving and system shut-down functions, it can also send warning messages via SMS, e-mail etc.

- Use the bundled CD and follow the on-screen instructions to install the software.
- Enter the following serial No. to install software:
511C1-01220-0100-478DF2A
- After the software is successfully installed, the communication with UPS has been established and a green icon will appear in the system tray.



- Double-click the icon to use the monitoring software (as above).
- You can schedule UPS shutdown/start-up and monitor UPS status through PC.
- Detail instructions please refer to the e-manual in the software.



Check www.powerwalker.com/winpower.html from time to time to get the latest version of monitoring software.

8. Maintenance

I. General

The UPS is virtually maintenance free: take care of proper environmental conditions and keep air inlets-outlets free of dust.

II. Fuses

If the AC input fuse is defect, be sure it is replaced by a compatible fuse from the same make and type.

Never short circuit batteries. When working with batteries, remove watches, rings and other metal objects, and only use insulated tools.

III. Battery-module replacement



Read all safety rules before replacing the battery.

Battery tray removal on tower models.

This operation must be performed when the UPS is switched OFF, and unplugged from AC source.

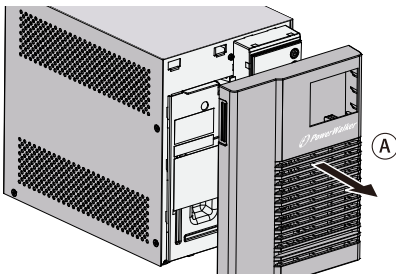

A - Remove the front panel.

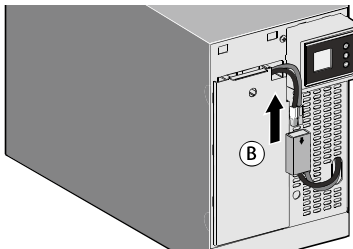

B - Disconnect the battery block by separating the two connectors (never pull on the wires).

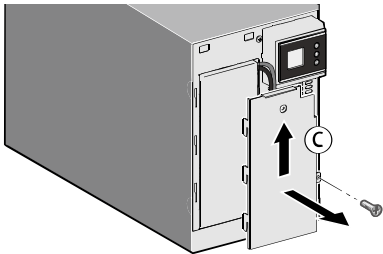

C - Remove the metal protection cover in front of the battery (one screw).

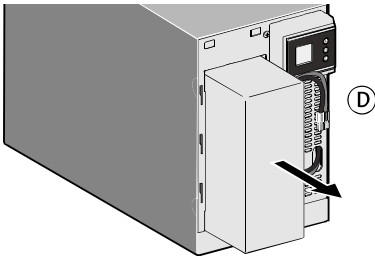

D - Pull the plastic tab to remove the battery block and replace it.

Mounting the new battery module

Carry out the above instructions in reverse order.

- To ensure safety and high performance, use only batteries supplied by BLUEWALKER.
- Take care to firmly press together the two parts of the connector during remounting

9. Trouble Shooting

EN

Symptom	Possible Cause	Remedy
No LCD display on the front panel.	1. Battery isn't connected.	1. Reconnect battery.
	2. Battery defect.	2. Replace with the same type of battery.
	3. On/Off button is not pressed.	3. Press the On/Off button again.
Alarm buzzer beeps continuously when AC supply is normal.	1. Overload of the UPS.	Verify that the load matches the UPS capability specified in the specs.
	2. Power cord is loose.	Reconnect the power cord properly.
When power failure, back-up time is shorten.	1. Overload of the UPS.	1. Remove some non-critical load.
	2. Battery voltage is too low.	2. Charge battery 6 hours or more.
	3. Battery defect due to high temperature operation environment, or improper operation to battery.	3. Replace with the same type of battery.

If any abnormal situations occur that are not listed above, please call service people immediately.

10. Specifications

Model	Complete Series			
	VI 500T/HID	VI 750T/HID	VI 1000T/HID	VI 1500T/HID
INPUT				
Voltage	220/230/240 VAC			
Voltage Range	184~276 VAC			
OUTPUT				
Voltage	220/230/240 VAC			
Voltage Regulation	-10%/+6% of nominal voltage range(Line mode)			
Frequency Range	50/60Hz			
Frequency Regulation	±1Hz (Battery mode)			
Transfer Time	Typical 3-7ms, 10ms max			
Waveform	Pure Sine Wave			
PROTECTION				
Full protection	Discharge, overcharge and overload protection			
ENVIRONMENT				
Humidity	0-90 % RH @ 0° to 40° C (non-condensing)			
Noise Level	Less than 40dB	Less than 40dB @Line mode Less than 45dB @Battery mode		
Software				
Monitoring Software	WinPower (included)			
CAPACITY	500VA / 350W	750VA / 500W	1000VA / 700W	1500VA / 900W
BATTERY				
Type & Number	12V/7Ah x1	12V/ 9Ah x1	12V/7Ah x2	12V/9Ah x2
Charging Time	3 hours recover to 90% capacity			
Backup Time (Half SPS load)	10min	9min	11min	8min
PHYSICAL				
LCD Indicator	View Area: 30mm x 30mm (AC Mode, Backup Mode)			
Outlet and Connector	4 * IEC 320 C13 outlets, USB port, RJ11/RJ45 Surge Protection		8 * IEC 320 C13 outlets, USB port, RJ11/RJ45 Surge Protection	
Dimension (WxHxD)	150 mmx 209mm x 240mm		150mm x 209mm x 340mm	
WEIGHT				
Net weight	6.3kg	6.8kg	10.5kg	11.5kg

